



Aircraft Tire Care & Maintenance



GOODYEAR

Introduction



The purpose of this manual is to help aircraft owners and maintenance personnel obtain optimum service from their bias and radial aircraft tires. The discussions contained in this part are designed not only to teach how to properly operate and maintain aircraft tires, but also to demonstrate why these techniques and procedures are necessary. Any information in this manual can be overridden by instructions from the tire or aircraft manufacturer.

Aircraft operating conditions require a wide variety of tire sizes and constructions. The modern aircraft tire is a highly-engineered composite structure designed to carry heavy loads at high speeds in the smallest and lightest configuration practical. Tires are a multi-component item consisting of three major materials: steel, rubber and fabric. There are different types of fabric and rubber compounds in a tire construction, each with its own special properties designed to successfully complete the task assigned.

Goodyear aircraft tire technology utilizes Computer Aided Design and Analysis, as well as the science of compounds and materials applications. Materials and finished tires are subjected to a variety of laboratory, dynamometer, and field evaluations to confirm performance objectives and obtain certification.

The manufacturing process requires the precision assembly of tight-tolerance components and a curing process under carefully controlled time, temperature and pressure conditions. Quality assurance procedures help to ensure that individual components and finished tires meet specifications. The Goodyear Innovation Center and all Goodyear Aviation Tire new and retread tire plants are ISO 9001:2000 certified.

NOTE: The procedures and standards included in this manual are intended to supplement the specific instructions issued by aircraft and wheel/rim manufacturers.

Notice: This Aircraft Tire Care and Maintenance Manual effective 01/2020 combines information from previous Goodyear Aircraft Tire Care and Maintenance manuals and supersedes all previous manuals.

Contents

INTRODUCTION	1
1. <u>GENERAL DATA</u>	5
<u>Bias Ply Aircraft Tire Construction</u>	5
<u>Radial Ply Aircraft Tire Construction</u>	7
<u>Tire Terminology</u>	9
<u>Bias and Radial Aircraft Tire Guidelines</u>	10
<u>Tire Marking</u>	10
<u>Aircraft Tire Serial Number Codes</u>	11
2. <u>TIRE AND TUBE STORAGE</u>	12
<u>Tire and Tube Age Limit</u>	12
<u>Storage of Mounted Assemblies</u>	13
<u>Matching Dual Tires</u>	13
3. <u>MOUNTING PROCEDURES</u>	14
<u>Aircraft Wheels</u>	14
<u>Wheel Manufacturer's Instructions</u>	14
<u>Safety Precautions with Wheels</u>	14
<u>Balance Pads</u>	15
<u>Tube Type</u>	15
<u> Tubes in Tubeless Tires</u>	16
<u>Tubeless Tires</u>	16
<u>Inflation Pressure Loss in Tube Type Assemblies</u>	17
<u>Inflation Pressure Loss in Tubeless Assemblies</u>	17
<u>Special Procedures – Emergency Tire Stretch</u>	19
4. <u>PREVENTIVE MAINTENANCE</u>	20
<u>Proper Inflation Procedures</u>	20
<u>Procedures for Hot Tire Inflation Pressure Checks</u>	22
<u>Casing Flat Spotting</u>	23
<u>Special Procedures – Above Normal Braking Energy</u>	23
<u>Protecting Tires From Chemicals and Exposure</u>	23
<u>Condition of Airport and Hangar Floor Surfaces</u>	24
<u>Aircraft Tire Conductivity</u>	24
<u>Tire Balancing and Landing Gear Vibration</u>	25
5. <u>INSPECTING MOUNTED TIRES</u>	26
<u>Treadwear</u>	26
<u>Return to Base Limits</u>	26
<u>Uneven Wear</u>	26
<u>Tread Cuts</u>	26
<u>Sidewall Damage</u>	26
<u>Bulges</u>	26
<u>Fabric Fraying/Groove Cracking</u>	27
<u>Flat Spots</u>	27

Contents

Casing Flat Spotting 27

Radial Tire Sidewall Indentation 27

Beads 27

Tire Clearance..... 27

Wheels..... 27

Inflation Pressure Loss in Tire/Wheel Assemblies..... 27

Rim Slip..... 27

Typical Treadwear Patterns and Conditions 28

Sidewall Conditions 33

Bead Conditions..... 34

Casing Conditions..... 34

Shipping Inflation 35

Shipping and Handling Damage 35

6. DEMOUNTING..... 36

7. AIRCRAFT TIRE PROPERTIES 37

Tire Size Classifications..... 37

Aircraft Tire -vs- Other Tire Applications 38

8. EFFECTS OF OPERATING CONDITIONS..... 39

Centrifugal Force 39

Traction Wave..... 40

Heat Generation..... 43

Tensile, Compression and Shear Forces..... 48

Tire Inflation..... 53

9. ADDITIONAL RESOURCES..... 54

FAA AC 20-97B..... 54

1. General Data

Bias Ply Aircraft Tire Construction

Bias aircraft tires feature a casing which is constructed of alternate layers of rubber-coated ply cords which extend around the beads and are at alternate angles substantially less than 90° to the center line of the tread. This diagram contains all the potential components of a bias tire. Due to design parameters, your tire may or may not contain all pictured components.

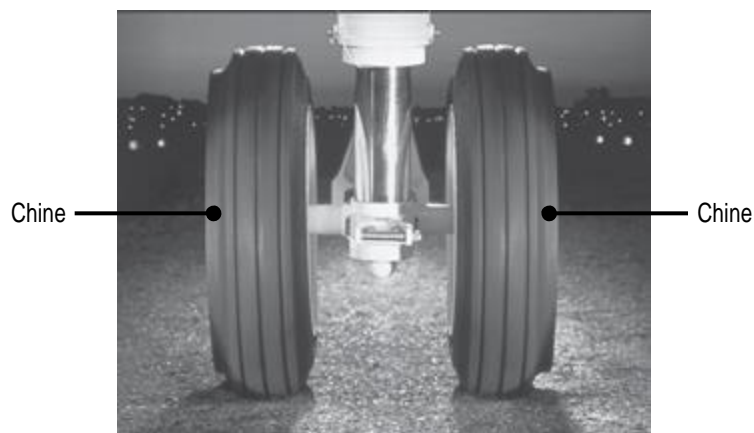
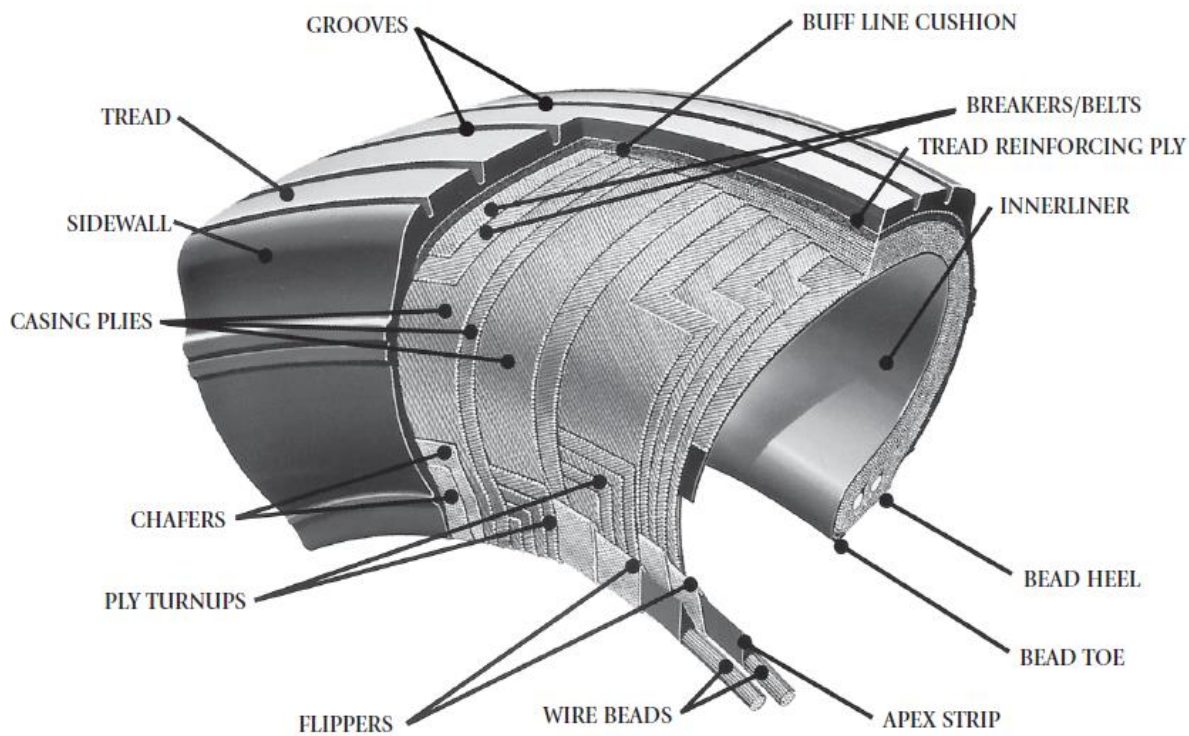

Glossary - Bias

Apex Strip	The apex strip is a wedge of rubber affixed to the top of the bead bundle.
Bead Heel	The bead heel is the outer bead edge that fits against the wheel flange.
Bead Toe	The bead toe is the inner bead edge closest to the tire centerline.
Breakers	Breakers are reinforcing plies of rubber-coated fabric placed under the buff line cushion to help protect casing plies and to strengthen and stabilize the tread area. They are considered an integral part of the casing construction. The cords of breakers are not substantially aligned with the circumference of the tire.
Buff Line Cushion	The buff line cushion is made of rubber compounded to enhance the adhesion between the tread reinforcing ply and the top breaker or casing ply. This rubber layer is of sufficient thickness to allow for the removal of the old tread when the tire is retreaded.
Casing Plies	Plies are layers of rubber-coated fabric (running at alternate angles to one another) which provide the strength of the tire.
Chafer	A chafer is a protective layer of rubber and/or fabric located between the casing plies and wheel to minimize chafing.
Chines	Also called deflectors, chines are circumferential protrusions that are molded into the sidewall of some nose tires that deflect water sideways to help reduce excess water ingestion into the engines. Tires may have chines on one or both sides, depending on the number of nose tires on the aircraft.
Flippers	These layers of rubberized fabric help anchor the bead wires to the casing.
Grooves	Circumferential recesses between the tread ribs.
Liner	In tubeless tires, this inner layer acts as a built-in tube and helps to restrict gas from diffusing into the casing plies. For tube-type tires the liner helps prevent tube chafing against the inside ply.
Ply Turnups	Casing plies are anchored by wrapping them around the wire beads, thus forming the ply turnups.
Sidewall	The sidewall is a protective layer of flexible, weather-resistant rubber covering the outer casing ply, extending from tread edge to bead area.
Tread	The tread is the outer layer of rubber which serves as the only interface between the tire and the ground. It provides traction for directional control and braking.
Tread Reinforcing Ply	Tread reinforcing plies are one or more layers of fabric that help strengthen and stabilize the tread area for high-speed operation. It also serves as a reference for the buffing process in retreadable tires.
Tubes	A flexible hollow rubber ring that is inserted inside a pneumatic tire to hold inflation pressure. Goodyear branded tubes meet SAE standard AS50141.
Wire Beads	The beads are hoops of high tensile strength steel wire which anchor the casing plies and provide a firm mounting surface on the wheel.

General Data

Radial Ply Aircraft Tire Construction

Radial aircraft tires feature a flexible casing which is constructed of rubber-coated ply cords which extend around the beads and are substantially at 90° to the centerline of the tread. The casing is stabilized by an essentially inextensible circumferential belt. This diagram contains all the potential components of a radial tire. Due to design parameters, your tire may or may not contain all pictured components.

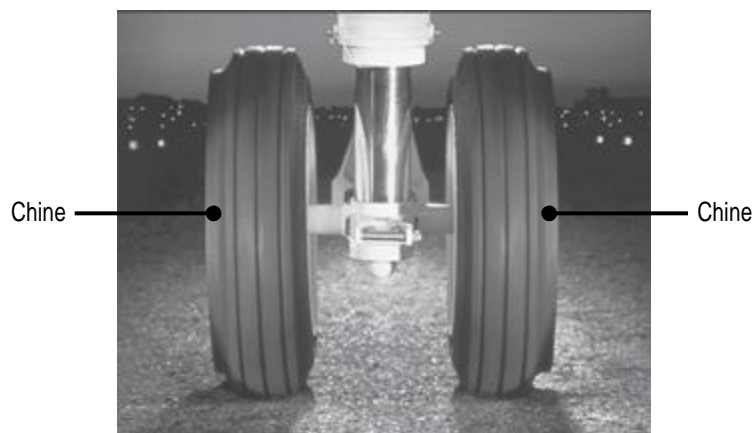
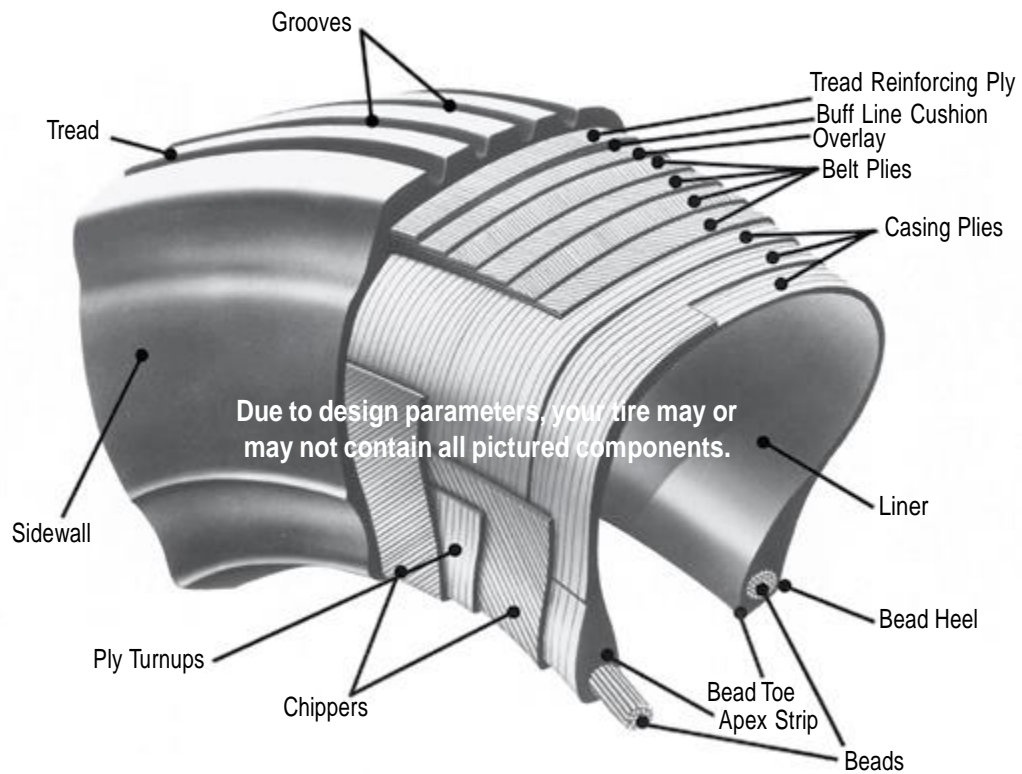

Glossary - Radial

Apex Strip	The apex strip is a wedge of rubber affixed to the top of the bead bundle.
Bead Heel	The bead heel is the outer bead edge that fits against the wheel flange.
Bead Toe	The bead toe is the inner bead edge closest to the tire center line.
Belt Plies	Belts are a composite structure of rubber-coated fabric which stiffen the tread area for increased landings. The belt plies increase the tire strength in the tread area. The cords of belts are substantially aligned with the circumference of the tire.
Buff Line Cushion	The buff line cushion is made of rubber compounded to enhance the adhesion between the tread reinforcing ply and the overlay. This rubber layer is of sufficient thickness to allow for the removal of the old tread when the tire is retreaded.
Casing Plies	Casing plies are layers of rubber-coated fabric which run radially from bead to bead. The casing plies help provide the strength of the tire.
Chippers	The chippers are layers of rubber-coated fabric applied at a diagonal angle which improve the durability of the tire in the bead area.
Chines	Also called deflectors, chines are circumferential protrusions that are molded into the sidewall of some nose tires that deflect water sideways to help reduce excess water ingestion into the engines. Tires may have chines on one or both sides, depending on the number of nose tires on the aircraft.
Grooves	Circumferential recesses between the tread ribs.
Liner	This inner layer of rubber acts as a built-in tube and helps to restrict gas from diffusing into the casing plies.
Overlay	The overlay is a layer of reinforcing rubber-coated fabric placed on top of the belts to aid in high speed operation.
Ply Turnups	Casing plies are anchored by wrapping them around the wire beads, thus forming the ply turnups.
Sidewall	The sidewall is a protective layer of flexible, weather-resistant rubber covering the outer casing ply, extending from tread edge to bead area.
Tread	The tread is the outer layer of rubber which serves as the only interface between the tire and the ground. It provides traction for directional control and braking.
Tread Reinforcing Ply	Tread reinforcing plies are one or more layers of rubber-coated fabric that helps strengthen and stabilize the tread area for high-speed operation. This also serves as a reference for the buffing process in retreadable tires.
Wire Beads	The beads are hoops of high tensile strength steel wire which anchor the casing plies and provide a firm mounting surface on the wheel.

Tire Terminology

PLY RATING - The term “ply rating” is used to indicate an index to the load rating of the tire. Years ago when tires were made from cotton cords, “ply rating” did indicate the actual number of plies in the carcass. With the development of higher-strength fibers such as nylon, fewer plies are needed to give an equivalent strength. Therefore, the definition of the term “ply rating” (actual number of cotton plies) has been replaced to mean an index of carcass strength or a load carrying capacity.

RATED LOAD - This is the maximum allowable load that the tire can carry at the specified rated inflation pressure.

RATED PRESSURE - Rated pressure is the maximum inflation pressure to match the load rating. Aircraft tire pressures are given for an unloaded tire; i.e, a tire not on an airplane. When the rated load is applied to the tire, the pressure increases by 4% as a result of a reduction in air volume.

OUTSIDE DIAMETER - This measurement is taken at the circumferential center line of an inflated tire.

SECTION WIDTH - This measurement is taken at the maximum cross sectional width of an inflated tire.

RIM DIAMETER - This is the nominal diameter of the wheel/rim on which the tire is mounted.

SECTION HEIGHT - This measurement can be calculated by using the following formula:

$$\text{Section Height} = \frac{\text{Outside Diameter} - \text{Rim Diameter}}{2}$$

ASPECT RATIO - Measure of the tire’s cross section shape. This can be calculated by the following formula:

$$\text{Aspect ratio} = \frac{\text{Section Height}}{\text{Section Width}}$$

FLANGE HEIGHT - This is the height of the wheel rim flange.

FLANGE DIAMETER - The diameter of the wheel including the flange.

FREE HEIGHT - This measurement can be calculated by using the following formula:

$$\text{Free Height} = \frac{\text{Outside Diameter} - \text{Flange Diameter}}{2}$$

STATIC LOADED RADIUS - This is the measurement from the center of the axle to the runway for a loaded tire.

LOADED FREE HEIGHT - This measurement can be calculated by using the following formula:

$$\text{Loaded Free Height} = \text{Static Loaded Radius} - \frac{\text{Flange Diameter}}{2}$$

TIRE DEFLECTION - A common term used when talking about aircraft tires is the amount of deflection it sees when rolling under load. The term % Deflection is a calculation made using the following formula:

$$\% \text{ Deflection} = \frac{\text{Free Height} - \text{Loaded Free Height}}{\text{Free Height}}$$

Most aircraft tires are designed to operate at 32% deflection, with some at 35%. As a comparison, cars and trucks operate in the 5% to 20% range.

SERVICE LOAD (OPERATIONAL LOAD) – Load on the tire at max aircraft takeoff weight.

SERVICE PRESSURE (OPERATIONAL PRESSURE) – Corresponding pressure to provide proper deflection at service load.

RATED SPEED – Maximum speed to which the tire is qualified.

Bias and Radial Aircraft Tire Guidelines

Radial aircraft tires may exhibit different characteristics than bias aircraft tires when operated under similar conditions. The following guidelines are recommended:

1. The airframe must be certified for use of radial tires in place of bias or vice versa. Questions concerning the certification of a given aircraft must be referred to the airframe manufacturer.
2. Radial aircraft tires should not be mounted on wheels designed for bias ply tires or bias tires on wheels designed for radial tires without first checking with the wheel manufacturer.
3. It is acceptable to mount bias tires on nose positions and radial tires on main positions, or vice versa, on the same aircraft.
4. For Return to Base Operation Only: In case a tire replacement is needed in a remote location, the position may be filled with an appropriate tire of the other construction for return to base operation only.

Tire Marking

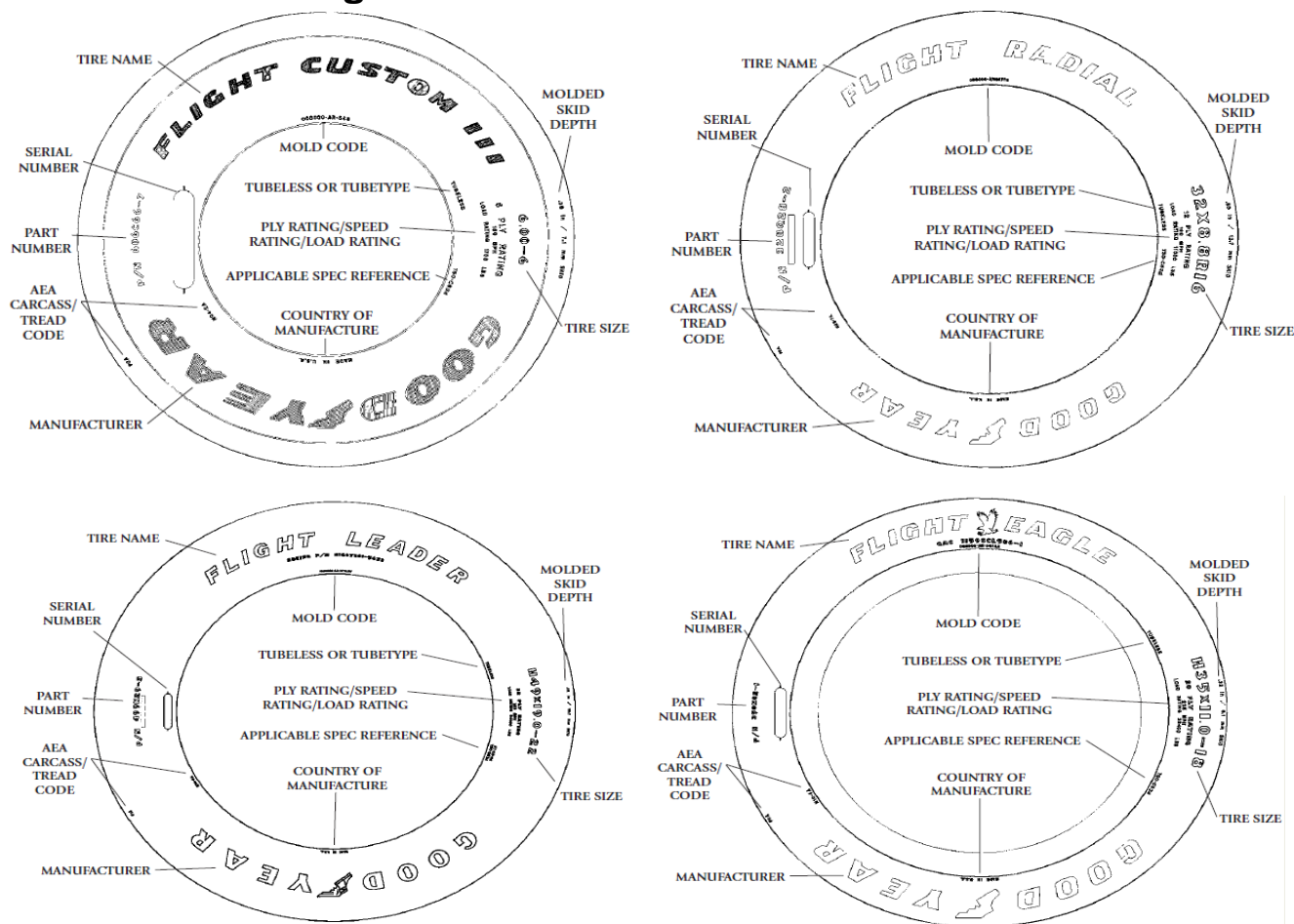

All Goodyear commercial aircraft tires are clearly marked with the following information: Goodyear, size, load rating, speed rating, molded skid depth, Goodyear part number, serial number, Goodyear plant identification and TSO marking. In addition, Goodyear tires are marked with the ply rating and other markings as required by airframe manufacturers or other organizations, such as an AEA code (which defines new tire casing and tread construction).

General Data

All TSO-C62b qualified tires with a speed rating of 160 mph or less and all TSO-C62c and TSO-C62d qualified tires do not require requalification to TSO-C62e unless the tire is changed.

Tires retreaded by all of Goodyear's facilities have the following information marked in the shoulder: the size, ply rating, speed category, retread plant and/or country of retreading, as well as retread level (R-Level), date of retreading and retread AEA code if appropriate.

Aircraft Tire Serial Number Codes

Goodyear serials consist of 8 characters, showing the date and plant of manufacture. Each tire has a unique code.

The digits are organized:

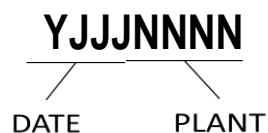

Positions 1-4 (YJJN) represent the year (Y) and Julian Date (JJN) of production.

Positions 5-8 (NNNN) show the decade and plant of manufacture.

Plant	Even Decade (2000, 2020...)	Odd Decade (1990, 2010...)
Danville	0001 to 2000	2001-4999
Thailand	5001 to 5500	5501-5999
Brazil	7100 to 7500	7501-7999

NOTE: Prior to 2001, tires produced in Thailand showed a 'T' in the 5th position, and tires produced in Brazil had a 'B' in the 5th position.

EXAMPLES

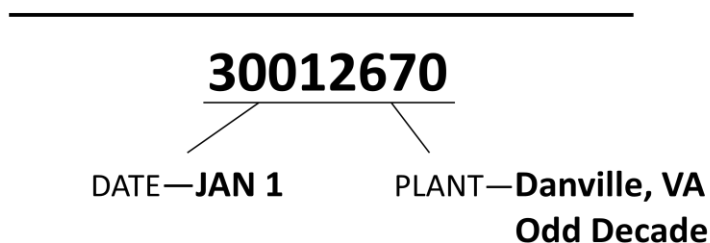

This tire was manufactured on Jan 1, 2013 in the Danville, VA plant.

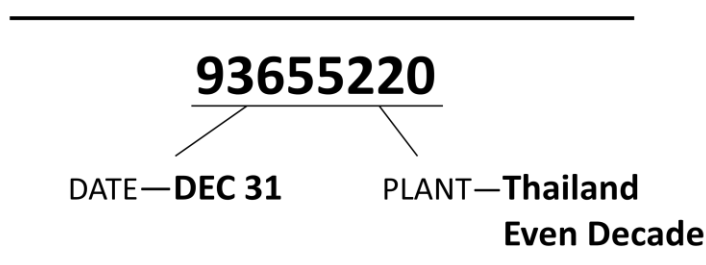

This tire was manufactured on Dec 31, 2009 in the Thailand plant.

2. Tire and Tube Storage

Ideally, both new and retreaded tires and tubes should be stored in a cool, dry place out of direct sunlight. Temperatures should be between 32°F (0°C) and 85°F (30°C). Particular care should be taken to store tires away from fluorescent lights, electric motors, battery chargers, electric welding equipment, electric generators and similar equipment. These items create ozone, which has a deteriorating effect on rubber.

Local aviation authority regulations may address limits to tire and tube storage humidity limits. Goodyear recommends following all local authority requirements.

Care should be taken that tires do not come in contact with oil, gasoline, jet fuel, hydraulic fluids or similar hydrocarbons. Rubber is attacked by these in varying degrees. Be particularly careful not to stand or lay tires on floors that are covered with these contaminants.

All tires and tubes should be inspected immediately upon receipt for shipping and handling damage.

Whenever possible, tires should be stored vertically on tire racks. The surface of the tire rack against which the weight of the tire rests should be flat and wide to minimize distortion.

Axial (circumferential) rotation of unmounted, vertically stored tires should not be required. With respect to the effect of storage time on rotation, we strongly suggest the use of first-in first-out (FIFO) storage. This helps to avoid storage-related field issues.

Stacking of most tires is permissible; however, care must be used to prevent distortion of the tires on the bottom of the stack. To prevent chine distortion, stacking chine/water deflector tires is not recommended. Tires stored in racks, but leaning on the chine, can also cause distortion. The following is the maximum recommended stacking height:

Tire Diameter	Maximum Recommended Stacking Height
Up to 40 inches	5
Over 40 inches to 49 inches	4
Over 49 inches	3

Tubes should be stored in their original cartons whenever possible. If stored without their cartons, they should be lightly lubricated with talc powder and wrapped in heavy paper.

Tubes can also be stored in matching tires. Tires should be clean and lightly lubricated with talc with tubes inflated just enough to round them out.

Under no circumstances should tubes be hung over nails, pegs or any object that might form a crease in the tube. Such a crease will eventually produce a crack in the rubber.

Tire and Tube Age Limit

Age is not an indicator of tire serviceability. Goodyear aircraft tires or tubes have no "expiration date" as long as all service criteria (Section 4 of this manual), visual criteria (Section 5), or individual customer-imposed restrictions are met.

It is recommended that tubes not be reused; they can grow as much as 25% in service. Reusing them can result in folded, pinched tubes which can fail or create an imbalance.

Storage of Mounted Assemblies

Set the pressure at operational pressure for the desired tire if allowed by the aviation authorities. The assemblies can be stored like this for up to 12 months. After that time, inflated assemblies that have not been used should be re-inspected to tire appearance criteria. These reinspections can be performed multiple times as long as the tire meets all inspection and inflation criteria. However, to obtain optimum service from the tire, it is recommended to rotate inventory on a first-in-first-out (FIFO) basis.

If the tire does not meet the inspection and inflation criteria, the tire should either be scrapped or returned for retreading, depending on the tire's condition. For assemblies stored for extended periods of time, inflation pressure retention checks should be performed to help re-verify the airworthiness of the assembly.

These recommendations do not supersede local storage facility regulations, ground transportation restrictions, or prevailing aviation authority requirements. Depending on local regulations, it may be the operator's responsibility or the tire handler (shipping or storage)'s responsibility to ensure compliance with the requirements for the locations in which they operate, transport, and store mounted tire assemblies.

Matching Dual Tires

When new and/or retreaded tires are installed on the same landing gear axle, the diameters do not have to be matched, as long as the dimensions are within the Tire and Rim Association inflated dimensional tolerances for new and grown tires. This will insure that both tires will carry an equal share of the axle load.

Data for new tire diameters after a 12 hour stretch period, at rated inflation pressure, are available in Goodyear's Aircraft Tire Data book. The maximum grown diameter is calculated using Tire and Rim or ETRTO formulas, and these formulas are also found in Goodyear's Aircraft Tire Data book. If help is needed with these calculations, please contact your local Goodyear representative.

3. Mounting Procedures

Correct mounting and demounting of aircraft tires and tubes are essential for maximum safety and economy. It is a specialized job that should be done only by fully trained persons with the proper tools and with careful attention to specific instructions and established procedures.



WARNING

Aircraft tires are designed to be operated up to or at rated inflation pressure. Exceeding these pressures may cause the aircraft wheel or tire to explode, which can result in serious or fatal injury.

Pressure Regulators should always be used to help prevent injury or death caused by overpressurization of the tire assembly. Maintenance and use of pressure regulators should be performed in accordance with the manufacturer's instructions. The safety practices for mounting and demounting aircraft tires referenced in the aircraft and wheel manufacturer's maintenance manuals should be followed.

NEWLY ASSEMBLED TIRES AND WHEELS SHOULD BE INFLATED IN SAFETY CAGES.

Aircraft Wheels

Aircraft wheels made today, for tube-type and tubeless tires, are the split wheel or demountable flange variety. While this makes the job of mounting and demounting physically easier, strict attention to detail is required.

Wheel Manufacturer's Instructions

Specific instructions on modern wheels are contained in maintenance manuals available from the aircraft manufacturer or directly from the wheel manufacturer. You should not mount or demount aircraft tires without the specific information contained in these manuals. In addition, refer to aircraft manual on use of incline ramps and/or jacks for maintenance purposes.

Safety Precautions with Wheels

An inflated tire/wheel assembly is potentially explosive. Mounting and demounting of aircraft tires is a specialized job that is best done with the correct equipment and properly trained personnel and with careful attention to specific instructions and established procedures.



WARNING

FAILURE TO COMPLY WITH THE FOLLOWING INSTRUCTIONS MAY CAUSE TIRE/TUBE/WHEEL FAILURE AND SERIOUS OR FATAL INJURY.

Bead lubrication in mounting both tubeless and tube-type tires is often desirable to facilitate mounting and seating of the beads against the wheel flanges. A light coat of talc can be used. Use the following guidelines for mounting:

- Use a clip-on chuck, an extension hose, and a safety cage for inflation.
- Use a direct reading or dial type pressure gauge with 5 psi increments that is calibrated on a regular basis.
- When inflating a tire/wheel assembly, regulate the supply line to a pressure no more than 50% higher than the tire service pressure.
- Do not inflate a tire above rated pressure to seat beads.

Mounting Procedures

Balance Pads

Some tires have a pad(s) installed on the inside to aid in the balance of the tire. More information can be found in Section 5. Inspecting Mounted Tires.



IMPORTANT

Do not attempt to remove a balance pad. This can result in damage to the liner.

Tube Type



IMPORTANT

A new tube should be used when installing a new tire. Tubes grow in service, taking a permanent set of about 25% larger than the original size. This makes a used tube too large to use in a new tire, which could cause a wrinkle and lead to tube failure.



IMPORTANT

For inspection use only enough pressure to round out tube. Excessive inflation strains splices and valve assemblies. Do not inflate tube larger than tire.



IMPORTANT

Ensure that any manufacturing stickers on the tire innerliner are removed to prevent damage to the tube.

- Use the correct tire and tube for the wheel assembly.
- Inspect the tube, looking for cuts or cracks.
- Inspect the inside of the tire, and remove stickers.
- Clean the bead base with a cloth dampened with denatured alcohol. Allow bead seat area to dry.
- Clean inside of tire, then lubricate lightly with talc.
- Inflate tube to slightly round, and insert in tire.
- Align valve on tube with red balance dot on tire.
- When mounting tire and tube on wheel, be sure that wheel bolts are torqued to wheel manufacturer's instructions before inflating.
- Inflate tire in a safety cage to rated pressure using dry nitrogen or shop air; comply with FAR 25.733.
- Deflate assembly to equalize stretch.
- Reinflate to rated pressure.
- After 12 hour stretch period, reinflate to rated inflation pressure.

Within the next 24 hours, if the pressure decreases more than 5%, pressure loss could be caused by trapped air between the tire and tube, valve core leakage, or a damaged tube. The assembly should not be placed into service.



IMPORTANT

Check inflation pressure daily or before first flight when tires are cool.

Tubes in Tubeless Tires

A Goodyear tubeless aircraft tire can be used (with a tube) in place of the same size tube-type tire if the tube-type tire has the same or lower speed and ply ratings.



IMPORTANT

Ensure that any manufacturing stickers on the tire innerliner are removed to prevent damage to the tube.



Sticker damage - damage of a tube from a tubeless tire without the removal of the stickers

When the tube and tubeless tire are initially mounted some air may be trapped between the tire and tube. Since tubeless tires have much thicker innerliners than tube-type tires, any air trapped will take longer to escape and will slowly reduce the inflation pressure as it does so. During the first two weeks after mounting, monitor the inflation pressure carefully and reinflate as required.

Tubeless Tires

A new O-ring seal with the correct part number should be used at each tire change following the wheel manufacturer's specifications.

- Check for word "Tubeless" on sidewall.
- Make sure tire is clean inside.
- Clean the bead base with a cloth dampened with denatured alcohol. Allow bead seat area to dry.
- Align red balance dot on the tire with wheel valve or wheel heavy point (if indicated on wheel). If no red dot appears on the tire, look in the liner for a balance pad. Align this area to the valve or heavy spot on the wheel. If no balance pad is in the tire, then align the tire serial number to the valve or heavy spot on the wheel.
- Be sure that wheel bolts are properly torqued per the wheel manufacturer's instructions.
- Inflate tire to rated pressure in a safety cage using dry nitrogen.
- After 12-hour stretch period, reinflate to rated inflation pressure with dry nitrogen.



IMPORTANT

Check inflation pressure daily or before first flight when tires are cool. Before placing assembly into service, perform a 24 hour pressure-retention check to ensure that the assembly is holding pressure properly.

Inflation Pressure Loss in Tube Type Assemblies

There are three reasons for inflation pressure loss in a tube-type tire:

1. A hole in the tube
2. A damaged valve stem
3. A nonfunctional valve core

Finding an inflation leak is usually simple. The first step is to check the valve and tighten or replace the core if it is defective. If the valve is not leaking, demount the tire, remove the tube, and locate the leak (by immersion in water if necessary). Replace the tube.

Inflation Pressure Loss in Tubeless Assemblies

Since there are many causes for inflation pressure loss with a tubeless assembly, a systematic troubleshooting approach is advisable. Moreover, when chronic but not excessive inflation pressure loss exists, other factors such as inaccurate gauges, air temperature fluctuations, changes in maintenance personnel, etc., may be the source. If a definite physical fault is indicated, a troubleshooting procedure similar to the one outlined below is recommended. (See wheel manufacturer's maintenance/overhaul manual for details pertaining to specific wheels.)

If pressure drops more than five percent (5%) in the 24 hours:

1. Check with water or soap solution:
 - improperly torqued or defective valve
 - valve core
 - valve seal
 - fuse plug
 - pressure release plug
 - O-ring seal
 - wheel base and flanges
2. If no leaks are found, rerun 24 hour diffusion check. If pressure still drops more than 5%, disassemble tire/wheel assembly.
 - Check wheel O-ring seal for condition, proper size and type, and lubricant.
 - Check wheel for cracks, porosity, fuse plug or pressure release plug malfunction.

Valve

Before deflating and removing tire, check the valve. Put a drop of water or soap solution on the end of the valve and watch for bubbles indicating escaping pressure. Tighten valve core if loose. Replace valve core if nonfunctional and repeat leak test to check. Check the valve stem and its mounting for leaks with a soap solution. If a leak is detected, deflate the tire/wheel assembly and replace the valve core and/or valve assembly. Make certain that every valve has a cap to retain inflation and prevent dirt, oil, and moisture from damaging the core.

Fusible Plug

The fusible plug may also be defective or improperly installed. Use a soap solution to check fusible plugs for leaks before removing tire. Leaks can usually be pinpointed to the plug itself (a poor bond between the fusible material and the plug body) or to the sealing gasket used. Be sure the gasket is one specified by the wheel manufacturer and that it is clean and free of cuts and distortion. If excessive heat has caused a fusible plug to blow, the tire may be damaged and should be replaced. After a fuse plug in a wheel blows, the wheel should be checked for soundness and hardness in accordance with the applicable wheel maintenance/overhaul manual. If the tire has not rolled, it can be sent to a retreader for inspection and possible retreading.

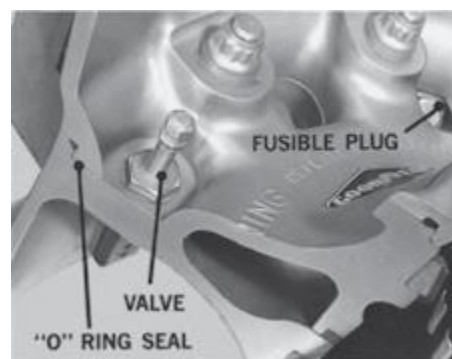

Split Rim Wheel

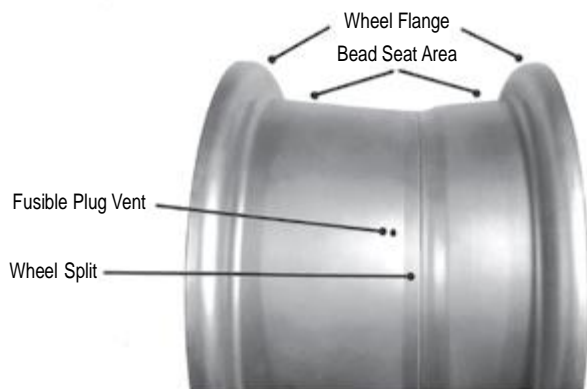

Demountable Flange Rim

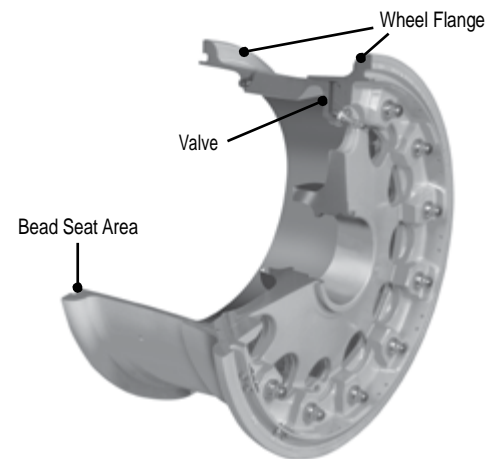

Release Plug

The inboard wheel half may contain a pressure release plug, a safety device that prevents accidental overinflation of the tire. If the tire is overinflated, the pressure release plug will rupture and release the tire pressure. A soap solution can be used to check a release plug to determine whether or not it is defective.

Wheel Base

Gas escaping through a cracked or porous wheel base is usually visible in an immersion test. Consult the wheel manufacturer's manual for rim maintenance and repair.

O-Ring Seal

A defective o-ring seal can usually be detected in an immersion test. Check to see that wheel bolts are properly torqued.

Beads and Flanges

Check the bead and flange areas of a tire for leaks before demounting. This can be done either by immersion or by using a soap solution. Any of the following factors can cause gas loss:

- Cracks or scratches in wheel bead ledge or flange area.
- Dirty or corroded wheel bead seating surfaces.
- Damaged or improperly seated tire bead.



Tire Casing

Before demounting, use an immersion test or soap spray to determine if the tire itself has a puncture. If a puncture is found in the tread or sidewall, the tire must be scrapped.

Casing Vents (Weep Holes)

All tubeless tires have been vented in the lower sidewall area during the tire manufacturing process. These vents prevent separation by relieving pressure buildup in the casing plies and under the sidewall rubber. These vent holes (marked by green dots) will not cause undue pressure loss and do not close. Covering them with water or a soap solution may show an intermittent bubbling, which is normal.

Mounting Procedures

Pressure Retention Test

When no leaks can be found on the prior checks, a pressure retention test must be performed. The tire should be inflated to operating pressure for at least 12 hours before starting the test. This allows sufficient time for the casing to stretch, but can result in apparent inflation pressure loss. The tire must be reinflated after the stretch period to operating pressure. Allow the tire to stand at constant temperature for a 24-hour period and recheck pressure.

Special Procedures – Emergency Tire Stretch

In an emergency situation, tires which must be placed in service without being inflated a minimum of 12 hours should be inflated to 105% of the unloaded service pressure. The tire/wheel/valve assembly should be sprayed with a soap solution and checked for abnormal leakage (abnormal leakage occurs when the soap solution bubbles between the tire and wheel or if a constant stream of bubbles is produced at the tire vents). If there is abnormal leakage, the tire/wheel assembly should be rebuilt according to normal procedures. If there is no abnormal leakage, the tire can be placed in service, as long as cold tire pressure is checked before every flight within the next 48 hours and the tire is re-inflated if necessary. Note: If the pressure drops below 90% of service pressure during these checks, follow the guidelines per the Cold Tire Service Pressure chart in this section.

4. Preventive Maintenance

Tires cannot be taken for granted on any aircraft. Tire maintenance costs will be at their lowest and tire life will be at its longest if proper maintenance practices are observed. Safe tire operation also depends on proper maintenance. Thus, preventive tire maintenance leads to safer, more economical operations.

Proper Inflation Procedures

NOTE: Keeping aircraft tires at their correct inflation pressure is the most important factor in any preventive maintenance program. The problems caused by incorrect inflation can be severe. Overinflation can cause uneven treadwear, reduce traction, make the tread more susceptible to cutting and increase stress on aircraft wheels. Underinflation produces uneven tire wear and greatly increases stress and flex heating in the tire, which shortens tire life and can lead to tire incidents. More information about the effects of improper inflation is available in the section "Effects of Operating Conditions."

INFLATION PRACTICES

1. CHECK DAILY OR BEFORE FIRST FLIGHT WHEN TIRES ARE COOL
2. AMBIENT TEMPERATURE EFFECTS ON INFLATION
3. USE DRY NITROGEN GAS (SAFELY)
4. INCREASE PRESSURE 4% FOR TIRES UNDER LOAD
5. ALLOW 12 HOUR STRETCH AFTER MOUNTING
6. NEVER REDUCE THE PRESSURE OF A HOT TIRE
REMEMBER - 1% PRESSURE CHANGE FOR 5°F (3°C)
7. EQUAL PRESSURE FOR DUALS
8. CALIBRATE INFLATION GAUGE REGULARLY

1. CHECK DAILY WHEN TIRES ARE COOL

Tire pressures should always be checked with the tire at ambient temperatures. Tire temperatures can rise in excess of 200°F (93°C) above ambient during operation. A temperature change of 5°F (3°C) produces approximately one percent (1%) pressure change. It can take up to 3 hours or more after a flight for tire temperatures to return to ambient.

A tire/wheel assembly can lose as much as five percent (5%) of the inflation pressure in a 24-hour period and still be considered normal. This means that tire pressures change on a daily basis. Even a tire which does not normally lose pressure can become damaged by FOD or other outside factors that can suddenly increase pressure loss. These are all reasons why it is important to check pressure daily or before each flight.

2. AMBIENT TEMPERATURE EFFECTS ON INFLATION

When tires are going to be subjected to ambient temperature differences between two locations in excess of 50°F (27°C), inflation pressures should be adjusted to the colder temperature prior to takeoff. An ambient temperature change of 5°F (3°C) produces approximately one percent (1%) pressure change. For example, tire pressure should be adjusted for a plane flying from Phoenix at 95°F (35°C) to Chicago at 45°F (7°C). The difference is 50°F (28°C), pressure should be increased by 10% before departing Phoenix. This also applies when checking pressure in a heated hangar in the winter.

3. USE DRY NITROGEN GAS

Nitrogen will not sustain combustion and will reduce degradation of the liner material, casing plies and wheel due to oxidation. Follow the appropriate regulatory agency requirements for nitrogen inflation. FAR 25 requires nitrogen inflation for an airplane with a maximum certified takeoff weight of more than 75,000 lbs.

4. INCREASE PRESSURE 4% FOR TIRES UNDER LOAD

It must be determined if “loaded” or “unloaded” pressure has been specified by the aircraft manufacturer. When a tire is under load, the gas chamber volume is reduced due to tire deflection. Therefore, if unloaded pressure has been specified, that number should be increased by four percent (4%) to obtain the equivalent loaded inflation pressure. The opposite is true as well: if loaded pressure has been specified, that number should be reduced by four percent (4%) if the tire is being inflated while unloaded.

5. ALLOW 12-HOUR STRETCH AFTER MOUNTING

All tires, particularly bias tires, will stretch (or grow) after initial mounting. This increased volume of the tire results in a pressure drop. Consequently, tires should not be placed in service until they have been inflated a minimum of 12 hours, pressure rechecked, and tires re-inflated if necessary.

6. NEVER REDUCE PRESSURE ON A HOT TIRE

Excess inflation pressure should never be bled off from hot tires. All adjustments to inflation pressure should be performed on tires cooled to ambient temperature. Procedures for hot tire inflation pressure checks are described later in this section.

7. EQUAL PRESSURE FOR DUALS

To prevent one tire on a gear from carrying extra load, all tires on a single gear should be inflated equally. The mate tire(s) will share the load, allowing individual tires to run underinflated or overloaded if pressures are unequal, because all tires on the gear will deflect identically.

8. CALIBRATE INFLATION GAUGE REGULARLY

Use an accurate, calibrated gauge. Inaccurate gauges are a major source of improper inflation pressures. Gauges should be checked periodically and recalibrated as necessary. Goodyear recommends the use of a digital or dial gauge with 5 PSI increments and a memory needle.

Mounted Tube-Type Tires

A tube-type tire that has been freshly mounted and installed should be closely monitored during the first week of operation, ideally before every takeoff. Air trapped between the tire and the tube at the time of mounting will seep out under the beads, through sidewall vents or around the valve stem, resulting in an underinflated assembly.

Mounted Tubeless Tires

A slight amount of gas diffusion through the liner material and casing of tubeless tires is normal. The sidewalls are purposely vented in the lower sidewall area to bleed off trapped gases, preventing separation or blisters. *A tire/wheel assembly can lose as much as five percent (5%) of the inflation pressure in a 24-hour period and still be considered normal.* If a soap solution is used to check leaks, it is normal for small amounts of bubbles to be observed coming from the vent holes.

COLD PRESSURE SETTING



The following recommendations apply to cold inflation pressure setting:

1. Minimum service pressure for safe aircraft operation is the cold unloaded inflation pressure specified by the airframe manufacturer.
2. The loaded service inflation must be specified four percent (4%) higher than the unloaded inflation.
3. A tolerance of minus zero (-0) to plus five percent (+5%) of the minimum pressure is the recommended operating range.
4. If “in-service” pressure is checked and found to be less than the minimum pressure, the following table should be consulted. An “in-service” tire is defined as a tire installed on an operating aircraft.

Preventive Maintenance

Cold Tire Service Pressure	Recommended Action
100 to 105 percent of loaded service pressure	None - normal cold tire operating range.
95 to less than 100 percent of loaded service pressure	Reinflate to specified service pressure.
90 to less than 95 percent of loaded service pressure	Inspect tire/wheel assembly for cause of pressure loss. Reinflate & record in log book. Remove tire/wheel assembly if pressure loss is greater than 5% and reoccurs within 24 hours.
80 to less than 90 percent of loaded service pressure	Remove tire/wheel assembly from aircraft (See NOTE below).
Less than 80 percent of loaded service pressure	Remove tire/wheel assembly and adjacent tire/wheel assembly from aircraft (See NOTE below).
0 percent	Remove tire/wheel assembly and adjacent tire/wheel assembly from aircraft. Scrap tire and mate if air loss occurred while rolling (See NOTE below).
<p>NOTE: Any tire removed due to a pressure loss condition should be returned to an authorized repair facility or retreader, along with a description of the removal reason, to verify that the casing has not sustained internal damage and is acceptable for continued service.</p>	

Procedures for Hot Tire Inflation Pressure Checks

	<p>WARNING</p> <p>DO NOT APPROACH A TIRE/WHEEL ASSEMBLY THAT SHOWS SIGNS OF PHYSICAL DAMAGE WHICH MIGHT COMPROMISE ITS STRUCTURAL INTEGRITY. THE TIRE COULD EXPLODE, WHICH CAN RESULT IN SERIOUS OR FATAL INJURY. IF SUCH CONDITIONS EXIST, REFER TO OPERATOR SAFETY PROCEDURES FOR DAMAGED TIRE/WHEEL ASSEMBLIES.</p>
	<p>IMPORTANT</p> <p>This procedure does not reduce or replace the need and importance of 24-hourly "cold" tire pressure checks.</p>

Goodyear recommends servicing tires cold every 24 hours, minimum. This procedure is not to be used as a replacement for cold tire pressure checks.

Do not reduce the pressure of a hot tire that is to continue in service.

Hot tires with pressures greater than 200% of the cold rated inflation pressure should be removed.

Procedure for Dual Mounted Tires:

- If a tire is 5 psi (or more) below its mate, inflate the tire to match the higher pressure mate.
- For equalizing mates, add no more than a 25% pressure increase above the cold tire specification pressure, even though the end pressure may not be within 5 psi between the mates.

Example #1:

- Cold tire specification = 200 psi.
- Tire #1 pressure = 220, mate pressure = 270.
- Set Tire #1 pressure to 250 psi, mate stays at 270 psi.
- 200 psi x 1.25 = 250 psi.
- **Note:** Both tire assemblies should be inspected to determine the cause of the pressure difference.

Preventive Maintenance

Example #2:

- Cold tire specification = 200 psi.
 - Tire #1 pressure = 220, mate pressure = 240.
 - Set Tire #1 pressure to 240 psi, mate stays at 240 psi.
- The hot tire pressure must at least be up to the normal cold tire specification pressure.
 - Hot tires found to be within 95% to 99% of the normal cold tire specification pressure should be removed and scrapped.
 - Hot tires found to be below 95% of the normal cold specification pressure should be removed with the mating tire and both scrapped.

Procedure for Different Gears:

- If one gear assembly is over 10 psi below the other gear assembly (comparing the lowest tire pressure from each gear), inflate the lower gear assembly tire pressures to match the lowest pressure tire on the higher pressure gear assembly.
 - For equalizing gear tires, add no more than a 25% pressure increase above the cold tire specification pressure, even though the end pressure may not be within 10 psi between the gear tires.

Casing Flat Spotting

Loaded tires that are left stationary for any length of time can develop temporary flat spots. The degree of this flat spotting depends upon the load, tire deflection and temperature. Flat spotting is more severe and more difficult to work out during cold weather. Occasionally moving a stationary aircraft can lessen this condition. If possible, an aircraft parked for long periods (30 days or more) should be jacked up to remove weight from the tires. Under normal conditions, a flat spot will disappear by the end of the taxi run.

Special Procedures – Above Normal Braking Energy

Tires that have been subjected to unusually high service braking or operating conditions such as HIGH ENERGY REJECTED TAKEOFFS or HIGH ENERGY OVERSPEED LANDINGS* should be removed and scrapped. Even though visual inspection may show no apparent damage, tires may have sustained internal structural damage. Consequently, affected tires inflated should be clearly marked and/or documented by serial number with a description of the reason for removal and returned to a full service tire supplier.

Tires that have deflated due to a FUSE PLUG RELEASE should be removed and scrapped. If this has occurred in dynamic (rolling) conditions, the mate tires have been subjected to high stress conditions and should also be removed. If this has occurred in a static (not rolling) condition, the mate tire does not have to be removed unless it fails to pass other AMM or applicable Goodyear CMM service or inspection criteria. For "HARD LANDINGS", the AMM should be followed. Also, all wheels should be checked in accordance with the applicable wheel maintenance/overhaul manual or aircraft manual.

Protecting Tires From Chemicals and Exposure

Tires should be kept clean and free of contaminants such as oil, hydraulic fluids, grease, tar, and degreasing agents which have a deteriorating effect on rubber. Contaminants should be wiped off with denatured alcohol, then the tire should be washed immediately with soap and water and inspected for surface damage such as blistering or softening. When aircraft are serviced, tires should be covered with a waterproof barrier. Tire coatings or dressings: Goodyear adds antioxidants and antiozonants to the sidewall and tread to help prevent premature cracking from ozone and weather exposure. There are many products on the market that are advertised to clean tires and to improve appearance and shine. Since many of these may remove the antioxidants and antiozonants, we do not endorse any of them unless the tires are to be used for display purposes only. Aircraft tires, like other rubber products, are affected to some degree by sunlight and extremes of weather. While weather-checking does not impair performance, it can be reduced by protective covers. These covers (ideally with light color or aluminized surface to reflect sunlight) should be placed over tires when an aircraft is tied down outside. Store tires away from fluorescent lights, electric motors, battery chargers, electric welding equipment and electric generators, since they create ozone which can have a deteriorating effect on rubber.

*Overspeed landings are those that exceed the tire speed rating.

Condition of Airport and Hangar Floor Surfaces

Regardless of the excellence of any preventive maintenance program, or the care taken by the pilot and ground crew in handling the aircraft, tire damage will certainly result if runways, taxi strips, ramps and other paved areas of an airfield are in a poor condition or improperly maintained. Foreign object damage (FOD) is the most common cause for early removals. Chuck holes, cracks in pavement or asphalt, or stepoffs from pavement to ground can cause tire damage. Pavement breaks and debris should be reported to airport personnel for immediate repair or removal. Another hazardous condition is the accumulation of loose material on paved areas and hangar floors. These areas should be kept clean of stones, tools, bolts, rivets and other foreign materials at all times. With care and caution in the hangars and around the airport, tire damage can be minimized. This photo shows items removed from tires that have been returned for retreading.



Many major airports throughout the world have modified their runway surfaces by cutting cross grooves in the touchdown and rollout areas to improve water runoff. This type of runway surface can cause a pattern of chevron-shaped cuts in the center of the tread. As long as this condition does not cause chunking or cuts into the fabric, the tire is suitable for continued service. See picture of a typical example of chevron cutting in the tread photos of section 5.

Aircraft Tire Conductivity

Tires dissipate some static electricity in service but this conductivity will change with the cleanliness of the tire surface, atmospheric conditions and runway surface. Since this discharge rate is variable and not very controllable, the tire cannot be counted on to dissipate static electricity. If there is any question about static charge build-up, the aircraft must be grounded by mechanical means.



CAUTION

Static electricity can spark, initiating a fire. Do not rely on tires to dissipate static electricity.

Tire Balancing and Landing Gear Vibration

It is important that aircraft wheels and tires be as well balanced as possible. Vibration, shimmy, or out of balance is a major complaint. However, in most cases, tire balance is not the cause.

Other factors affecting balance and vibration are:

- Flat-spotted tire due to wear and braking
- Out of balance wheel halves
- Installation of wheel assembly before full tire stretch
- Improperly torqued axle nut
- Improperly installed tube
- Use of non aircraft tubes
- Improperly assembled tubeless tire
- Poor gear alignment
- Bent wheel
- Worn or loose gear components
- Incorrect balancing of wheel assembly
- Pressure differences in dual mounted tires on the same axle
- Diameter differences in dual nose gear tires due to different levels of wear (check with aircraft manuals to see if nose tires need to be replaced in pairs)

With some split wheels, the light spot of the wheel halves is indicated with an "L" stamped on the flange. In assembling these wheels, position the "L's" 180 degrees apart. If additional static balancing is required after tire mounting, some wheels have provisions for attaching accessory balance weights around the circumference of the flange.

AIRCRAFT TIRE/WHEEL BALANCER FOR GENERAL AVIATION OPERATION



Balancing instructions for this tire/wheel balancer can be obtained from Desser Tire & Rubber Company: **800-AIR-TIRE (800-247-8473)**.

NOTE: The T.J. Karg Company tire/wheel balancer is no longer available.

5. Inspecting Mounted Tires

Systematic inspection of mounted tires is strongly recommended for safety and tire economy. The frequency of the inspection should be determined by the use and normal tire wear of the particular aircraft involved. With some aircraft, tire inspection after every landing or at every turnaround is required. With all aircraft, a thorough inspection is advisable after a hard landing.

Treadwear

Inspect treads visually and check remaining tread. Tires should be removed when tread has worn to the base of any groove at any spot, or up to 1/8 of the tire circumference.

Return to Base Limits

In order to return to a maintenance base, Goodyear tires can remain in service with top ply cord visible, but only as long as the cord is not worn through or exposed for more than 1/8 of the circumference of the tire or not more than 1 inch wide at the fastest wearing location. Tires within these limits can continue in service no longer than necessary to return to a maintenance base and be replaced. (This applies to the proper tires for the aircraft as specified in its aircraft manual.) For all other circumstances, normal removal criteria are still recommended as per the rest of this manual. This does not apply to military tires with Maximum Wear Limits marked on the sidewall.

NOTE: Further use of tires beyond return to base limits may render a tire unsafe or unretreadable.

Uneven Wear

If tread wear is excessive on one side, the tire can be demounted and turned around, provided there is no exposed fabric. Gear misalignment causing this condition should be corrected.

Tread Cuts

Inspect tread for cuts and other foreign object damage and mark with crayon or chalk. Follow the removal criteria below:

1. Follow specific cut removal criteria from the aircraft manual, or tire cut limits on the tire sidewall when available.
2. When specific cut removal criteria are not available use the following Goodyear removal criteria: any cut into the casing plies on bias tires, any cut into the belt package on radial tires, any cut which extends across one or more rubber tread ribs to the fabric, rib undercutting at the base of any cut.



WARNING

DO NOT PROBE CRACKS, CUTS, OR EMBEDDED FOREIGN OBJECTS WHILE TIRE IS INFLATED. THIS COULD CAUSE THE OBJECT TO BECOME A PROJECTILE OR THE TIRE TO EXPLODE, WHICH CAN RESULT IN DAMAGE, SERIOUS INJURY, OR DEATH.

Sidewall Damage

Remove tire from service if weatherchecking, cracking, cuts and snags extend down to the casing ply in the sidewall and bead areas.

Bulges

Bulges in any part of tire tread, sidewall or bead area may indicate a separation or damaged tire. Mark with crayon and remove from service immediately.

Fabric Fraying/Groove Cracking

Tires should be removed from service if groove cracking exposes fabric or if cracking undercuts tread ribs.

Flat Spots

Generally speaking, tires need not be removed because of flat spots due to touchdown and braking or hydroplaning skids unless fabric is exposed. If objectionable vibration results, however, rebalance the assembly or remove the tire from service.

Casing Flat Spotting

Loaded tires that are left stationary for any length of time can develop temporary flat spots. The degree of this flat spotting depends upon the load, tire deflection and temperature. Flat spotting is more severe and more difficult to work out during cold weather. Under normal conditions, a flat spot will disappear by the end of the taxi run.

Radial Tire Sidewall Indentation

Remove from service if sidewall indentation is 3mm deep or greater.

Beads

Inspect bead areas next to wheel flanges for damage due to excessive heat, especially if brake drag or severe braking has been reported during taxi, take-off or landing. If damaged, remove tire from service.

Tire Clearance

Look for marks on tires, gear, and in wheel wells that might indicate rubbing due to inadequate clearance.

Wheels

Check wheels for damage. Wheels that are cracked or damaged should be taken out of service for repair or replacement in accordance with manufacturer's instructions.

Inflation Pressure Loss in Tire/Wheel Assemblies

Refer to section on MOUNTING for a complete review of these procedures.

Rim Slip

After installation, several aircraft cycles may be necessary before a tire reaches its final position on the wheel. Tires that move in excess of 20 degrees should be demounted and evaluated for appropriate action unless otherwise instructed by the tire or aircraft manufacturer.

Typical Treadwear Patterns

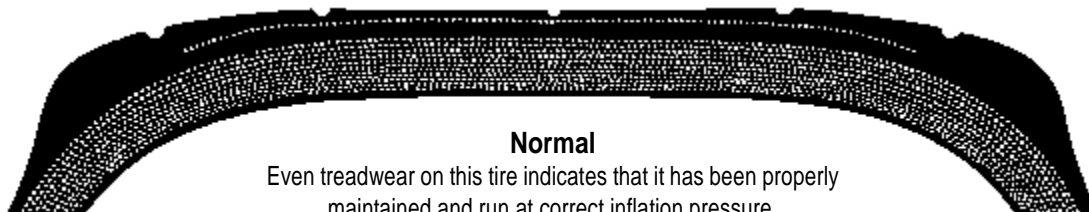

Normal

Even treadwear on this tire indicates that it has been properly maintained and run at correct inflation pressure.

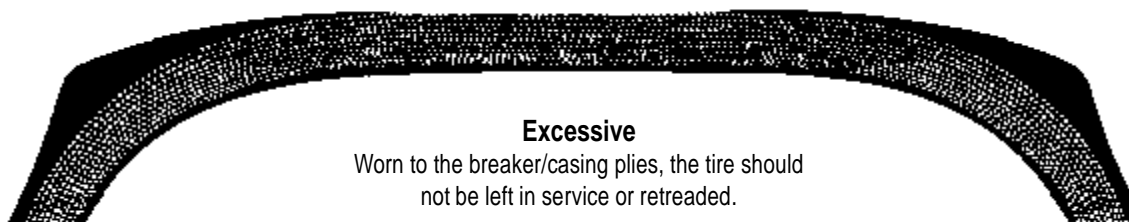

Excessive

Worn to the breaker/casing plies, the tire should not be left in service or retreaded.



Stepwear

This is a normal wear pattern on some tires, particularly H-type tires. Can be caused or worsened by underinflation.



Asymmetrical Wear

Some aircraft tires exhibit faster shoulder wear on one shoulder versus the other due to non-tire influences (camber-type wear, etc.). If this condition exists, the tire's life can be extended by demounting and reversing ("flipping") the tire on the wheel as long as tire wear limit and the physical condition criteria are satisfied.

IMPORTANT

"FLIPPING" MUST NOT BE DONE ON SINGLE CHINE TIRES

Inspecting Mounted Tires

Tread Conditions



Cuts

Penetration by a foreign object.

Action: See Section 5, Inspection, Storage and Shipping; Inspecting Mounted Tires; Tread Cuts.

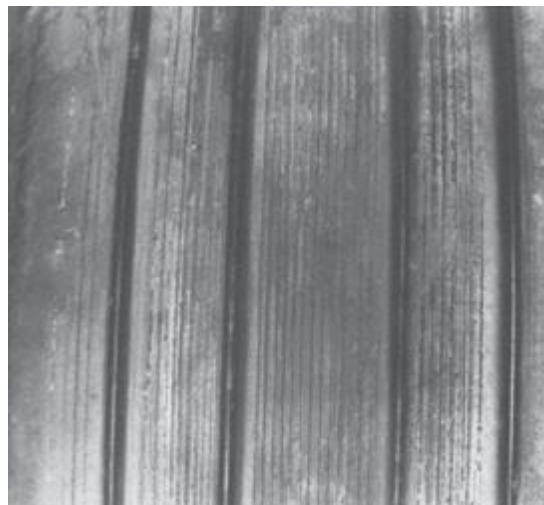

Spiral Wrap

Some retreads have reinforcing cords wound into the tread which become visible as the tire wears. This is an acceptable condition and not cause for removal. The wrap reduces chevron cutting and tread chunking.

Action: None.



Tread Chunking

A condition in the wearing portion of tread usually due to rough or unimproved runways.

Action: Remove from service if fabric is visible.



Tread Separation

A separation or void between components in the tread area due to loss of adhesion, usually caused by excessive loads or flex heating from underinflation.

Action: Remove from service.

Inspecting Mounted Tires



Groove Cracking

A circumferential cracking at the base of a tread groove. Can result from underinflated or overloaded operation, or improper storage conditions.

Action: Remove from service if fabric is visible for more than 0.25 inches.

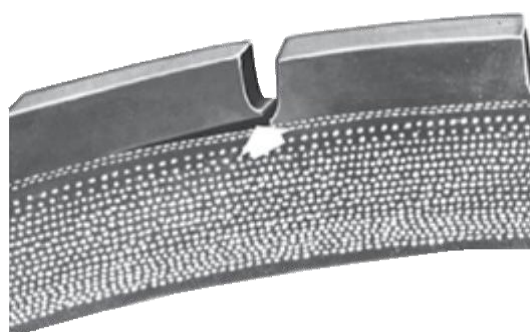

Rib Undercutting

An extension of groove cracking progressing under a tread rib; remove from aircraft. Can lead to tread chunking, peeled rib or thrown tread.

Action: Remove from service.



Peeled Rib

Usually begins with a cut in tread, resulting in a circumferential delamination of a tread rib, partially or totally, to tread reinforcing ply.

Action: Remove from service. If analysis is required or requested, obtain tread pieces for submission.



Thrown Tread

Partial or complete loss of tread down to tread fabric ply or casing plies.

Action: Remove from service. If analysis is required or requested, obtain tread pieces for submission. If the tire deflated, remove axle mate if applicable.

Inspecting Mounted Tires

Tread Conditions (Continued)

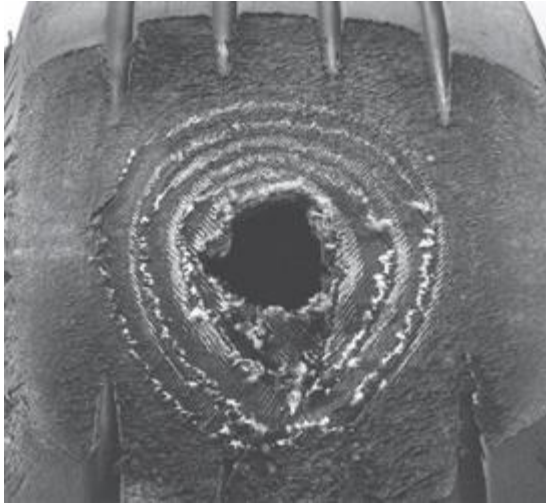

Skid

This occurs when the tire stops rotating while the aircraft is still moving. The runway grinds off rubber and fabric as the tire is dragged along the surface.

Action: Remove from service if balance is affected, fabric is exposed or tire is ruptured. Remove axle mate tire if ruptured.



Tread Rubber Reversion

An oval-shaped area in the tread similar to a skid, but where rubber shows burning due to hydroplaning during landing, usually caused by wet or ice-covered runways.

Action: Remove from service if balance is affected, or normal wear criteria is exceeded.



Open Tread Splice

A crack in the tread rubber where the joint (splice) separates in a radial (sideways) direction.

Action: Remove from service immediately.



Chevron Cutting

Tread damage caused by running and/or braking on cross-grooved runways.

Action: Remove from service if chunking to fabric occurs, tread cut removal criteria are exceeded, or normal wear criteria are exceeded.

Inspecting Mounted Tires

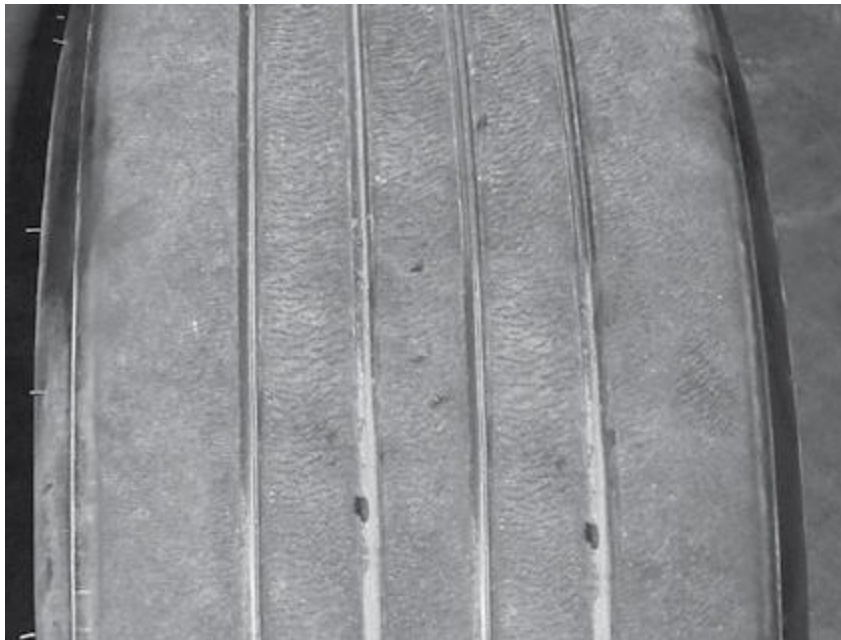

Heavy Braking

Heavy braking can create a pattern of abrasion. This will wear normally during service.
Action: None required.

General

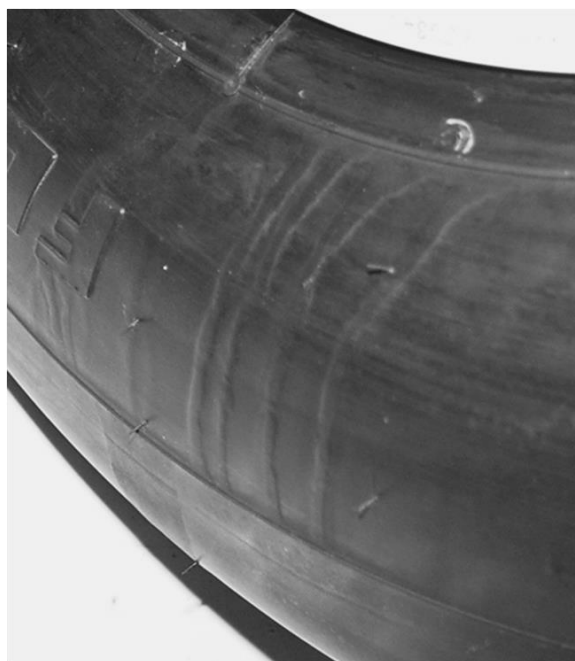

External Contamination

External contaminants such as fuel, oil, hydraulic fluid, Skydrol, etc. should be cleaned as soon as observed with denatured alcohol or soap and water. Remove if rubber is spongy to the touch.

Inspecting Mounted Tires

Sidewall Conditions



Cut or Snag

Penetration by a foreign object on runways and ramps, or in shops or storage areas.

Action: Remove from service if injury extends into fabric.

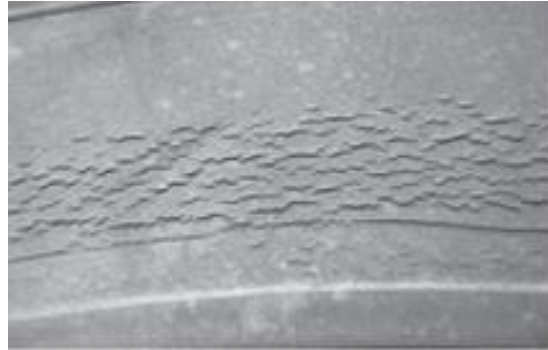

Ozone or Weather Checking/Cracking

Random pattern of shallow sidewall cracks usually caused by ozone deterioration, prolonged exposure to weather, or improper storage.

Action: Remove from service if fabric is visible.



Radial or Circumferential Cracks

Cracking condition found in the sidewall/shoulder area; remove from aircraft if down to fabric. Can result from underinflated or overloaded operation.

Action: Remove from service if fabric is visible.



Sidewall Separation

Bulge in sidewall rubber caused by a separation of sidewall rubber from the casing.

Action: Remove from service. Mark the affected area if analysis is desired.



Precure Paint

This substance is used to prevent the tire from sticking to the mold after curing. It can sometimes give the appearance of sidewall cracks.

Action: None required.

Bead Conditions

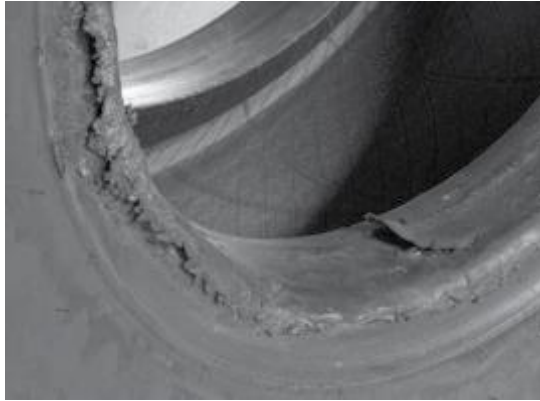

Brake Heat Damage

A deterioration of the bead face from toe to wheel flange area; minor to severe blistering of rubber in this area; melted or solidified nylon fabric if temperatures were excessive; very hard, brittle surface rubber.
Action: Remove from service.

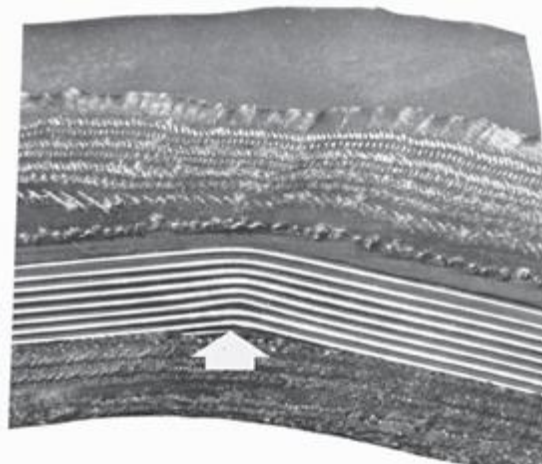

Kinked Bead

An obvious deformation of the bead wire in the bead toe, face or heel area. This can result from improper demounting and/or excessive spreading for inspection purposes.
Action: Remove from service.

Casing Conditions



Inner Tire Breakdown

Deterioration (distorted/wrinkled rubber of tubeless tire innerliner or fabric fraying/broken cords in tube-type) in shoulder area usually caused by underinflated or overloaded operation.
Action: Remove from service.



Impact Break

Rupture of tire casing in tread or sidewall area, usually from extremely hard landing or penetration by a foreign object.
Action: Remove from service.

Shipping Inflation

Transportation of a serviceable inflated aircraft tire wheel assembly is covered by the U.S. Department of Transportation, the International Air Transport Association (IATA), and other regulatory agencies.

While serviceable tires may be shipped fully pressurized in the cargo area of an aircraft, Goodyear's recommendation is to reduce pressure to 25% of operating pressure or 3 bars / ~40 psi, whichever is less. Reinflate to operating pressure before mounting on the aircraft.

Shipping and Handling Damage

In Goodyear's manufacturing facilities, stringent finished tire inspection is performed to help ensure that Goodyear tires are shipped to the customer in first class condition. Because of the characteristics of rubber, special care is taken to inspect shipping containers, pallets and trucks for obvious conditions that could cause damage to these tires. However, aircraft tires may be damaged during shipping or handling after the tires leave the control of our facilities and prior to entering service. Damage of this nature is the responsibility of the freight carrier and needs to be handled between the receiving facility and the freight handler as soon as possible after receipt of the tire(s). It should be kept in mind that some of this damage can be so slight that it escapes incoming inspection procedures and is noticed later or after the tire is mounted on the wheel assembly and inflated.

Cuts and snags can occur on tread areas, sidewalls and bead areas of tires. In many cases these cuts are caused by nails, wood, splinters, utility knives, forklift tines or sharp metal objects in transport trailers.

6. Demounting



WARNING

A tire/wheel assembly that has been damaged in service should be allowed to cool for a minimum of three (3) hours before the tire is deflated. The internal temperature and pressure are unknown.

EXTREMELY HIGH TEMPERATURES REDUCE THE STRENGTH OF THE PLIES WHICH COULD RESULT IN AN EXPLOSION CAUSING SERIOUS OR FATAL INJURY.

Goodyear recommends two types of demounting equipment: "full-circle" and partial-circle bead breakers. With both types of bead breakers, the desired procedures are a combination of pressing against the tire sidewalls close to the edge of the wheel flanges and controlling the lateral movement of the bead breaker rings after contacting the tire sidewalls. This procedure assures the maximum lateral force against the tire to demount it without internal tire damage or kinking the tire beads.

1. Prior to demounting the tire from the wheel, it should be completely deflated with a deflation cap.
2. After all the pressure has been relieved, remove the valve core. Remember that valve cores still under pressure can be ejected like a bullet. If wheel or tire damage is suspected, approach the tire from the front or rear, not from the side (facing the wheel).
3. Leave the wheel tire bolts tight until after unseating the tire beads. If the bolts are loosened or removed before unseating the tire beads, the wheel mating surfaces may be damaged.
4. Radial tires should be dismounted with full circle bead breaking equipment. Bias tires can be dismounted with full circle bead breaking equipment. If "full-circle" type bead breaking equipment is used, the appropriate bead breaker flange ID should be approximately 10 mm above the flange. For example, an H40x14.5-19 tire is mounted on a 19 inch diameter wheel with a 1.4 inch flange. So, 19 inch wheel diameter plus twice the wheel flange height of 1.4 inches plus the 20 mm (0.8 inch) clearance adds up to 22.6 inches, which is rounded to give a bead breaker flange ID of 23 inches. Also, the bead breaker flanges should be equipped with rubber or plastic pads to help prevent unwanted movement after contacting and compressing each tire sidewall approximately 1.5 inches, reducing the risk of damage to the aircraft wheel.
5. If partial-circle type bead breaking equipment is used, the same press tools are used for all size tires, but the press tools are raised or lowered to position them for each tire at the level of the center of the wheel and as close to the wheel OD as possible. This type of bead breaking equipment is equipped with sensors that prevent lateral movement after the press tools have compressed the tire approximately 3.5 inches (1.75 inches per side) and contacts the wheel. The tire can be turned on the bead breaker rollers and the breaking action repeated until the tire beads are unseated.

7. AIRCRAFT TIRE PROPERTIES

It is helpful to have some knowledge of aircraft tire properties to better understand some of the charts and graphs presented in this section. Some of the main properties are discussed on the following pages.

Unlike other tire types such as passenger and truck tires, aircraft tires are designed for intermittent operation. Because of this design feature, and to allow the low ground bearing pressure, the aircraft tire operates at much higher deflections than other tire types.

The Tire and Rim Association (T&RA) and European Tire and Rim Technical Organization (ETRTO) have standardized different manufacturers' tires and wheels (rims). Although tire size nomenclature has changed over the years, the T&RA and ETRTO have established standards for the load and pressure ratings of a given size tire.

Tire Size Classifications

Three Part Type All new sizes being developed are in this classification. This group was developed to meet the higher speeds and loads of today's aircraft. Note: Some sizes have a letter such as "H" or "B" in front of the diameter. This is to identify a tire that is mounted on a wheel which has a rim width approximately 65% of the tire section width. "B" designates a bead taper of 15 degrees rather than 5 degrees.

Metric Type This size designation is the same as Three Part except the diameter and section width dimensions are in millimeters, and the wheel/rim diameter is in inches.

Type VII This type covers most of the older sizes and was designed for jet aircraft with its higher load capacity and higher speeds.

Type III This type was one of the earliest size designations used for piston-prop type aircraft. Its characteristic is low pressure for cushioning and flotation.

Radial Radial size nomenclature is the same as Three Part except an "R" replaces the "-" (dash) before the wheel/rim diameter.

Tire Name Type	Tire Size Example	Nominal Diameter	Nominal Section Width	Nominal Wheel/Rim Diameter
Three Part	H49x19.0-22	49	19	22
Metric	670x210-12	670 (mm)	210 (mm)	12 (in)
Type VII	49x17	49	17	
Type III	8.50-10		8.5	10
Radial	32x8.8R16	32	8.8	16

For a complete listing of tire sizes and aircraft applications along with some engineering design parameters, consult the Goodyear Aircraft Tire Data Book. Contact your local Goodyear representative to receive a copy.

Aircraft Tire -vs- Other Tire Applications

Many people believe that all tires are alike. This chart shows a comparison of an aircraft tire versus one example of a passenger tire close to the same size. The tires may be similar in size, but that is where similarities end. Aviation tires are intended for intermittent use only.

Tire Comparison Aircraft - vs - Passenger		
PARAMETER	AIRCRAFT	PASSENGER
Size	27 x 7.75-15	P205/75R15
Diameter (in)	27.0"	27.1"
Section Width	7.75"	7.99"
Ply Rating	12	-
Load Rating	9650	1598
Pressure	200	35
Deflection	32%	11%
Max Speed	225	112
Load/Tire Weight	244	78

Comparing, in particular, the LOAD and SPEED ratings of these two tires, the aircraft tire carries up to 9650 lbs, which is approximately six times the passenger tire load of up to 1598 lbs. The aircraft tire also is designed to travel over twice as fast.

Also, notice that the operating pressure of the aircraft tire is almost 6 times that of the passenger tire; and that the aircraft tire is operating at a deflection of 32%, as compared to 11% for the passenger tire.

The **HEAVY LOAD** coupled with the **HIGH SPEED** of tires in aircraft applications make for extremely **SEVERE OPERATING CONDITIONS**. Several of the following charts describe these two major factors. The purpose of these charts is to present items that minimize and maximize these adverse effects. The ultimate goal is to not only understand the maintenance and operational requirements of aircraft tires, but why they are needed.

8. Effects of Operating Conditions

Centrifugal Force

CENTRIFUGAL FORCE is a combination of LOAD & SPEED

Both heavy loads and high speeds contribute to the strong centrifugal forces acting on an aircraft tire. The relationship of speed versus centrifugal force is readily understood. The effect of coupling speed with a heavy load is shown in the drawing below.

This drawing depicts a tire rotating counterclockwise. The heavy solid horizontal line represents the ground or runway. The distance "CX" is half the footprint length. Because the tire is pneumatic, it deflects when coming into contact with the ground. This deflection is represented by the distance "BC" or "XZ". In the same length of time that a point on the surface of the tire travels the last half of the footprint "CX", it must also move radially outward the distance "ZX".

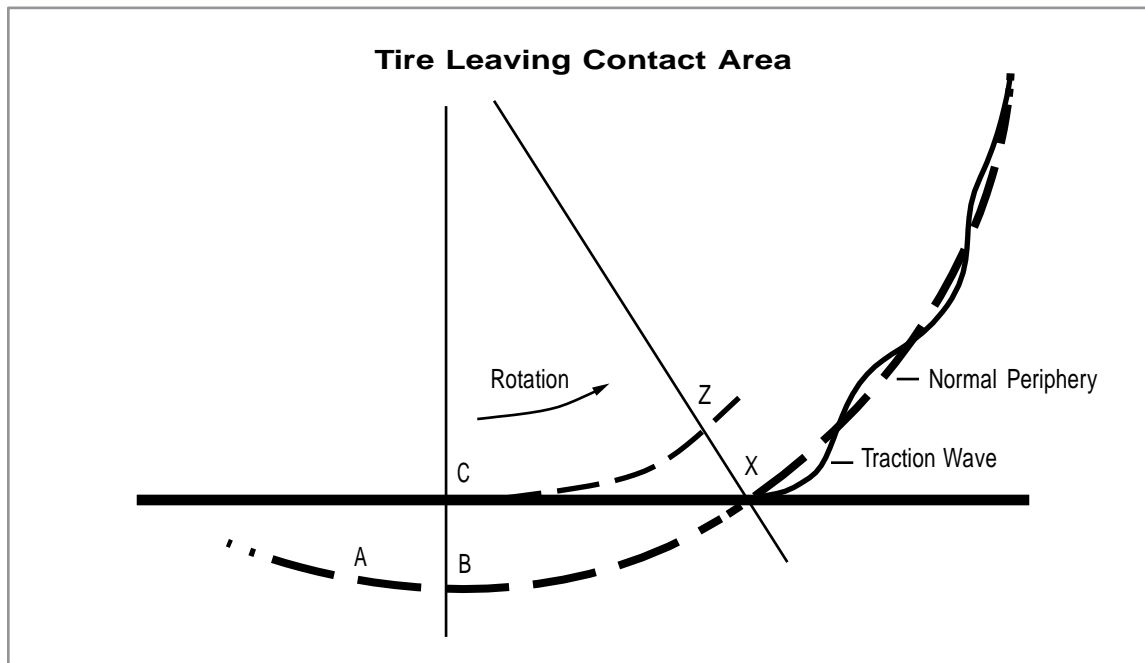

As the tire leaves the deflected area, it attempts to return to its normal shape. Due to centrifugal force and inertia, the tread surface doesn't stop at its normal periphery but overshoots, briefly distorting the tire from its natural shape. This sets up a traction wave in the tread surface.

Traction Wave

This photograph shows just how severe a traction wave can become:

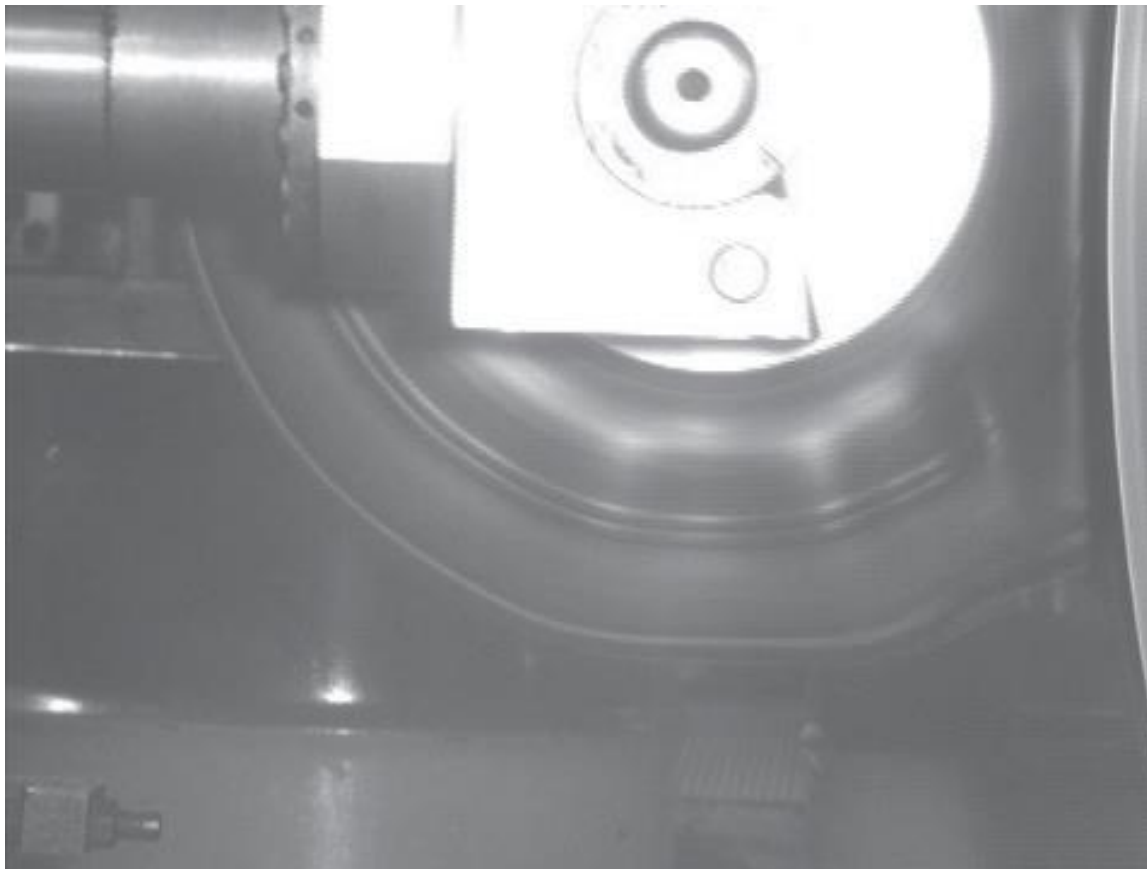

The following parameters help explain the magnitude of forces acting on the tire carcass and tread as it runs under extreme conditions on a test dynamometer.

Speed	250 MPH
Revolutions per Minute	4,200
Deflection	1.9 inches

At this speed, it takes only 1/800 of a second to travel 1/2 the length of the footprint (CX). In that same time, the tread surface must move radially outward 1.9 inches. This means an average radial acceleration of 200,000 ft./sec./sec. That's over 6,000 G's!

This means the tread is going through 12,000 to 16,000 oscillations per minute.

Obviously, a tire cannot withstand this type of punishment. How can a traction wave be reduced or eliminated? In other words, what factors affect the traction wave? The following page shows effects of **SPEED** and **UNDERINFLATION**.

Traction Wave -vs- Speed

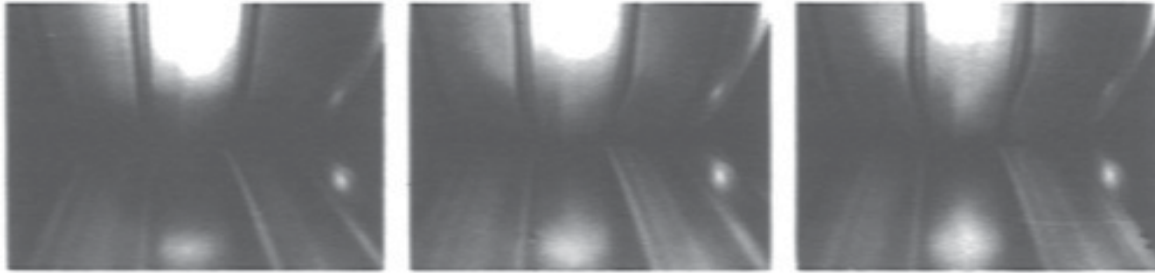

40X14 24 PR @ Rated Pressure

The above photographs show the tread of a tire as it leaves the footprint moving toward the reader. The only test variable is speed, showing from left to right 190, 210, 225 mph. The higher the speed, the more pronounced the traction wave.

One of the major tasks of the tire design engineer is to minimize this traction wave at the required speeds and loads.

Traction Wave -vs- Underinflation



40X14 24 PR 225 MPH

All tires in the above photographs are traveling at 225 mph. The only test variable is pressure, showing from left to right rated pressure, -10 psi, -15 psi, -20 psi. In the picture to the far left there is no appreciable traction wave because the tire is properly inflated. Obviously, the greater the underinflation, the more pronounced the traction wave.

Groove Cracking

Note how the grooves open and close as the tread passes through the traction wave. The centrifugal forces that generate a traction wave, combined with the thousands of revolution cycles, can cause tread problems such as groove cracking and rib undercutting, which could result in tread loss.

Groove Cracking - is a circumferential crack that can develop in the base of the groove caused by the repeated flexing of the groove when a traction wave is present. Tires should be inspected frequently and removed if any fabric is visible.

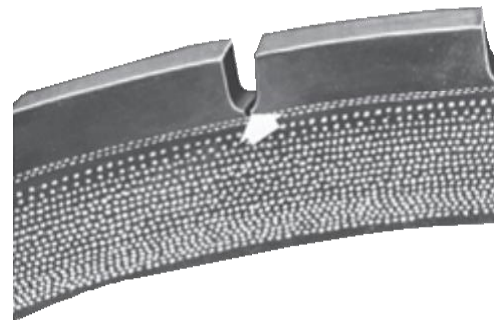

Effects of Operating Conditions

Rib Undercutting - is normally a continuation of the groove cracking that continues under the tread rib between the rubber and the tread reinforcing fabric

Rib undercutting can progress to a point where pieces of the rib or the whole rib can become separated from the carcass. In severe cases the complete tread can come off the carcass. Progression from deep groove cracks to undercutting and ultimate tread loss can occur rather quickly. Therefore, careful examination of the tires before each take-off is extremely important. The tire should be removed if the fabric is exposed.

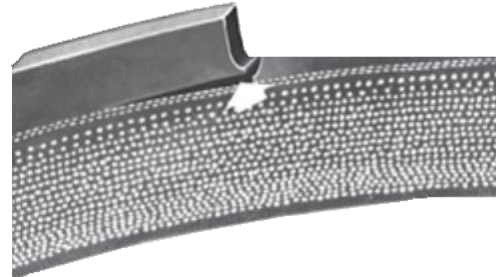

Before leaving the subject of centrifugal force, it is interesting to look at the magnitude of these forces due to speed only, disregarding other radial accelerations caused by loads and deflections. This chart shows the centrifugal forces acting on one ounce of tread rubber on a 30-inch diameter tire.

Centrifugal Forces 30-Inch Diameter Tire

MPH	Gs	Force on 1 oz of Tread	Force on Total Tread (8 lbs)
100	500	33 lbs	4000 lbs
200	2000	130 lbs	16,600 lbs
300	4500	300 lbs	38,500 lbs
400	8000	528 lbs	67,500 lbs

The force increases as the square of the speed from 500 Gs, or 33 lbs. per ounce, at 100 mph, to an extreme of 8000 Gs, or 528 lbs. per ounce, at 400 mph. An average tread for this size tire would weigh approximately 8 lbs. This means that the effective weight of the total tread at 200 mph would be 16,600 lbs. and at 400 mph would be 67,500 lbs. With forces like these, it is amazing that a tread can stay on an aircraft tire at all.

Effects of Operating Conditions

Heat Generation

As severe as the effects of these high centrifugal forces are, **HEAT** has a more detrimental effect. **HEAVY LOADS** and **HIGH SPEEDS** cause **HEAT GENERATION** in aircraft tires to exceed that of all other tires.

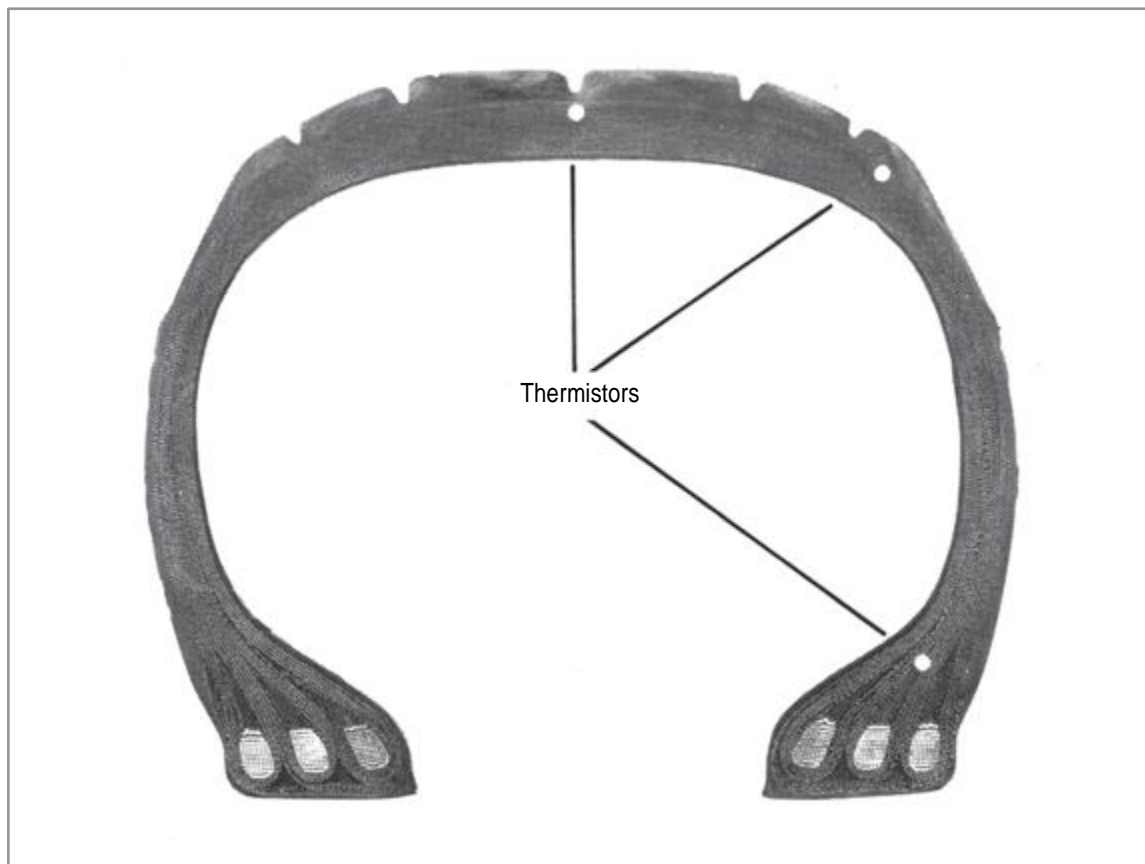

To understand the magnitude of heat generated in typical aircraft tires, several test tires were fitted with temperature sensors, or thermistors, mounted at the locations indicated. The actual temperature rise during a variety of free-rolling taxi tests was monitored and recorded. The following charts show the effect of taxi speed, inflation pressure, and taxi distance on internal heat generation for typical main landing gear tires.

Effects of Operating Conditions

Temperature Rise vs Taxi Speed

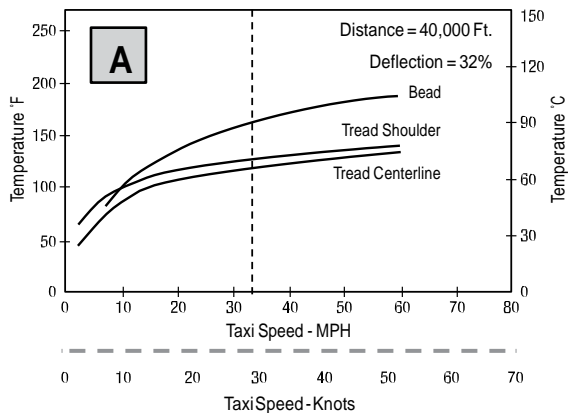

Temperature Rise vs Percent Deflection

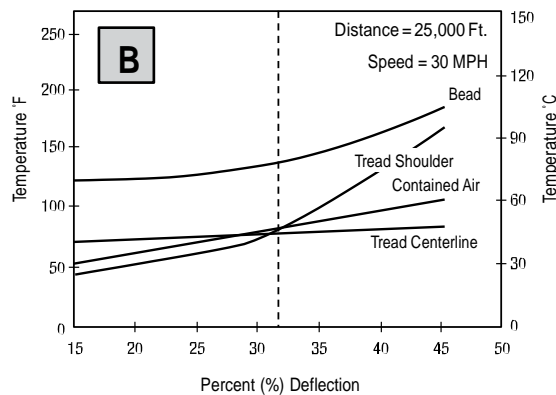

A The vertical dotted line at 35 mph (30 knots) indicates the recommended maximum taxi speed. On the above chart, the curves constantly slope upward with higher taxi speeds. In other words, the faster an aircraft travels over a given distance, the hotter the tires will become. Many people would expect the shoulder area to generate the most heat. In reality, the bead and lower sidewall area are the hottest. There are two major reasons for this:

1. All forces, in or acting on a tire, ultimately terminate at the bead. This is an area of high heat generation.
2. Rubber is a good insulator; or said another way, it dissipates heat slowly. The bead area, being the thickest part of the tire, retains the heat longer than any other part of the tire.

B This tire was designed to be operated at 32% deflection, as the vertical dotted line indicates. Left of this line designates overinflation, and to the right underinflation. When the speed and the distance traveled are constant, the more a tire is underinflated the hotter it becomes. The rate of temperature rise versus underinflation is the highest in the shoulder area due to increased flexing. The bead area, however, still remains hottest.

Temperature Rise vs Taxi Distance

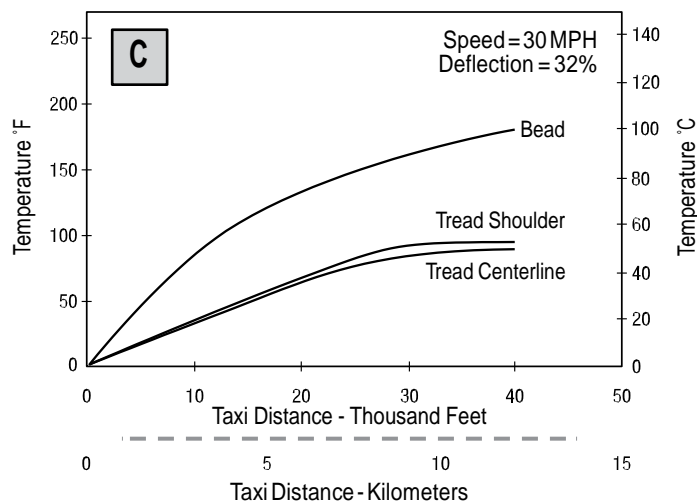

C Even when an aircraft tire is properly inflated and operated at moderate taxi speeds, the heat generation will always exceed the heat dissipated. (This is indicated by the ever increasing slope of the lines.) The farther the taxi distance, the hotter the tires will be at the start of the take-off.

Effects of Operating Conditions

Temperature Rise vs Taxi Distance

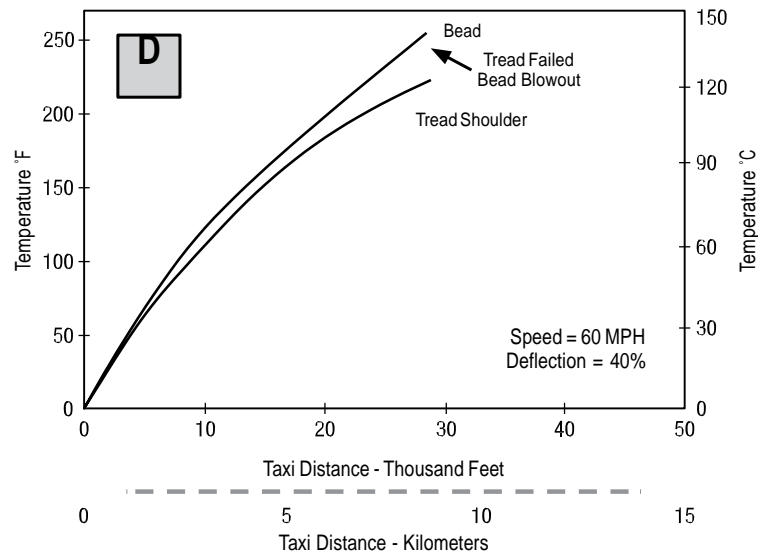

D This chart shows the effect of underinflation coupled with the high speed taxiing. Compare the heat generation between a tire run at 32% deflection in Chart C and this one run at 40% deflection. Not only is the slope of the 40% deflection curves much steeper (due to higher rate of heat generation) than the 32% curve, but the 40% deflection tire blew out in the lower sidewall after traveling about 30,000 feet.

Tensile vs Temperature

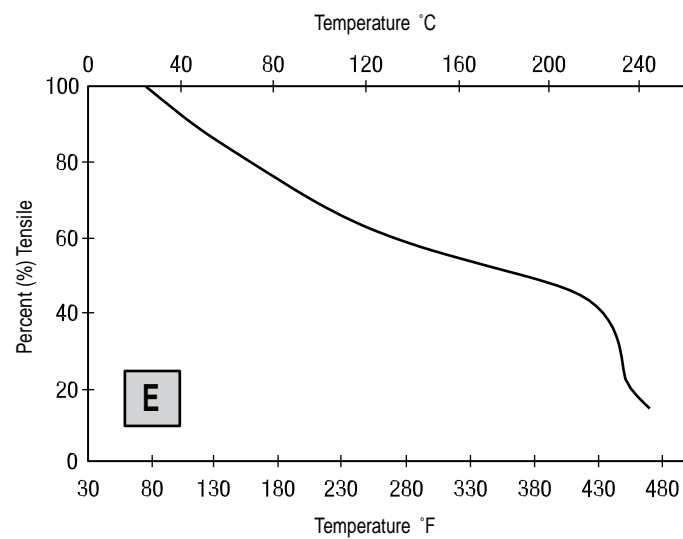

E The casing or body of the tire is usually made up of rubber-coated layers of nylon fabric which extend from bead to bead. This fabric, which is anchored around the bead bundles, is a structural member of the tire to give it shape and strength.

As good as nylon is, it has limitations. There is a reduction in strength when exposed to high temperatures. Nylon melts at temperatures slightly above 400°F (200°C).

Effects of Operating Conditions

Effect of Temperature on Rubber Compounds

EFFECTS	°F	°C
APPEARANCE OF BLUE COLOR	210 - 230	100 - 110
RUBBER REVERTS	280 - 320	140 - 160
RUBBER BECOMES HARD & DRY	355 - 390	180 - 200

The physical properties of rubber compounds are also susceptible to degradation by high temperatures. Both strength and adhesion are lost when the rubber reverts to the uncured state. The temperatures shown in the above chart are related to time. Brief exposure to these temperatures is not as damaging to the tire as are prolonged exposures.

Time for Tire Temperature to Dissipate

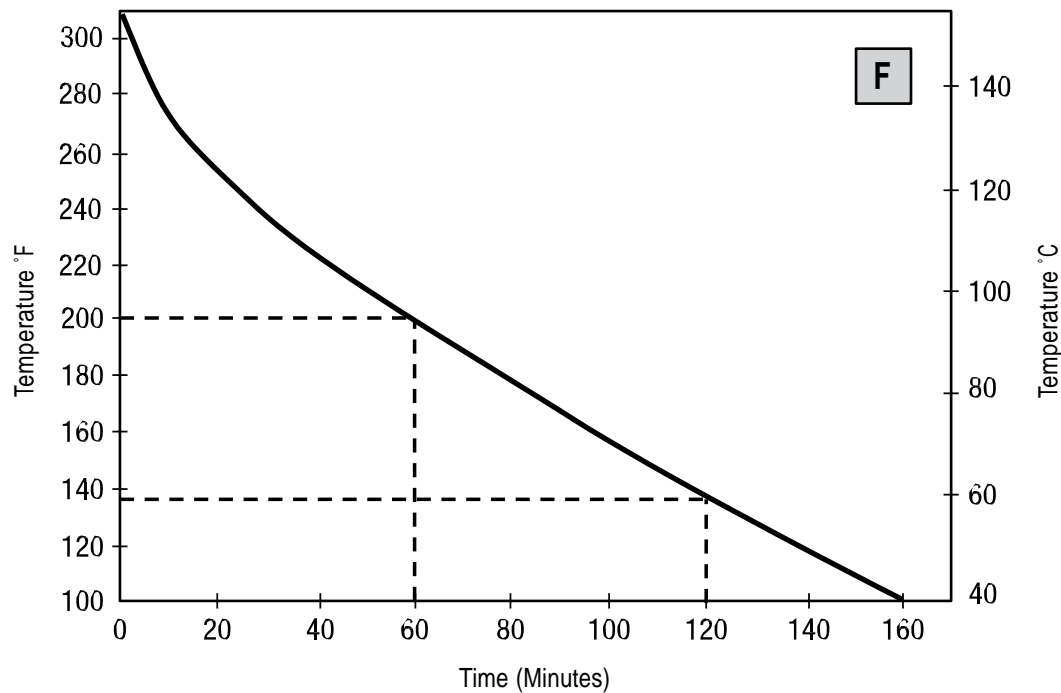

F On charts C and D it must be remembered that only temperature rise was indicated. Heat is cumulative. Chart F shows the time required to cool the bead area of a test tire with two fans blowing on it. This would equal approximately a 30 mph breeze. The curve indicates that the temperature in a hot tire drops 100°F in the first hour and somewhat less in subsequent hours. The cooling time of a tire mounted on an aircraft would be slightly longer due to the effect of brake temperature.

Effects of Operating Conditions

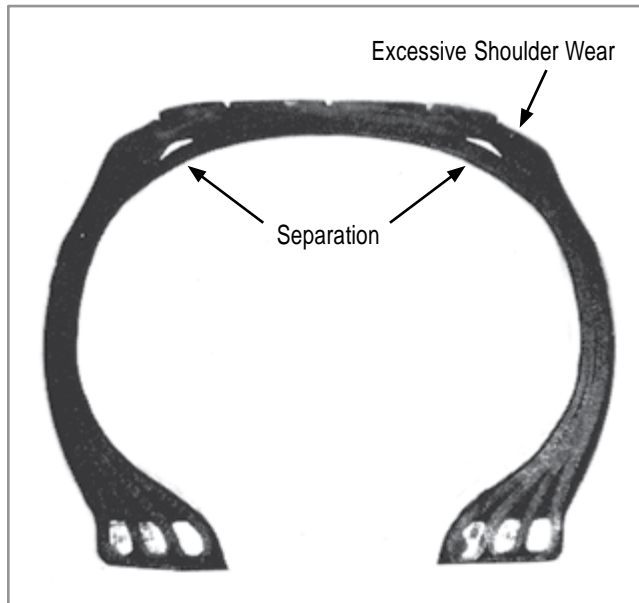

Tread & Casing Separations

Here we see separation in both shoulders. These would be visible on the outside as bulges. The wear pattern indicates this tire was run underinflated.

Action: Remove tire from service.

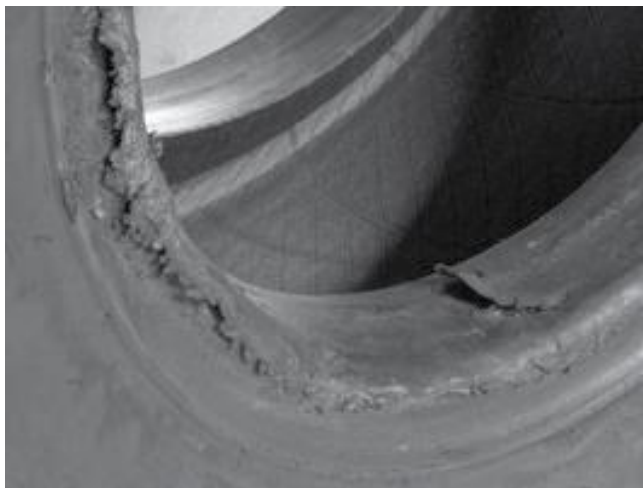

Bead Face Damage

Up to now, only heat generated internally has been discussed. This is an example of damage due to external heat from the brakes.

Action: Remove tire from service.

Tensile, Compression and Shear Forces

A discussion of aircraft tires would not be complete without showing the effect of **LOAD** and **SPEED** on the **TENSILE**, **COMPRESSION** and **SHEAR FORCES** within a tire.

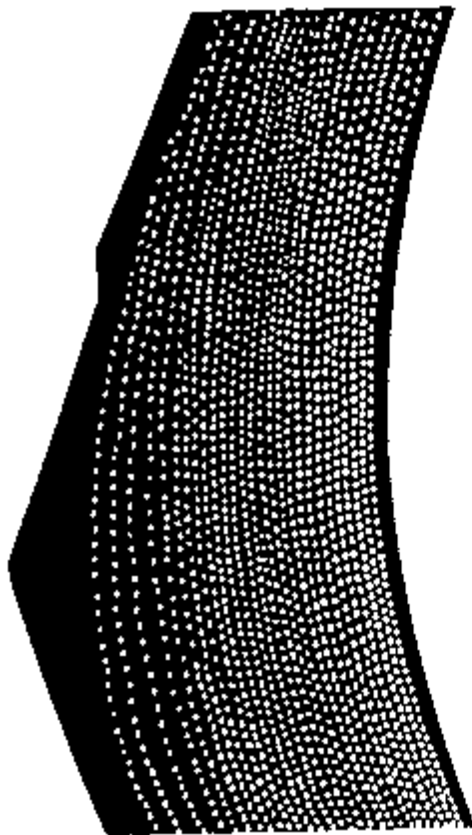

Unloaded Cross Section

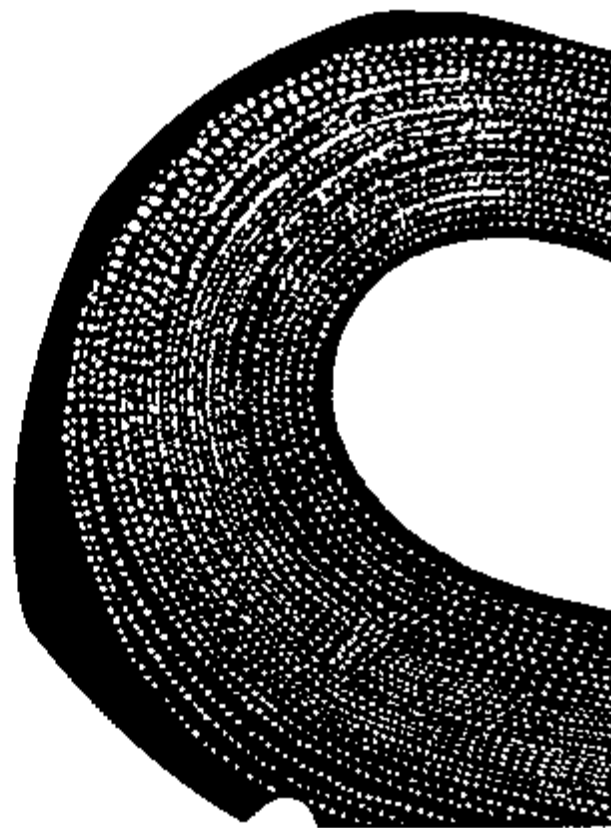

Loaded Cross Section

Tensile, compression and shear stresses can best be visualized by comparing an unloaded tire section to a loaded one as shown in the above photos. The following points can be made:

1. An aircraft tire is designed so that in the unloaded condition the internal tensile forces acting on each layer of fabric are uniform.
2. Due to the high deflection of the tire section under the load, the tensile forces on the outer plies will be higher than those on the inner plies.
3. Due to the force gradient from outer to inner plies, shear forces are developed between the various layers of fabric.
4. Underinflating or overloading a tire will increase these shear forces, thus rapidly decreasing the life of an aircraft tire.

Effects of Operating Conditions

Carcass Fatigue Due to Underinflation

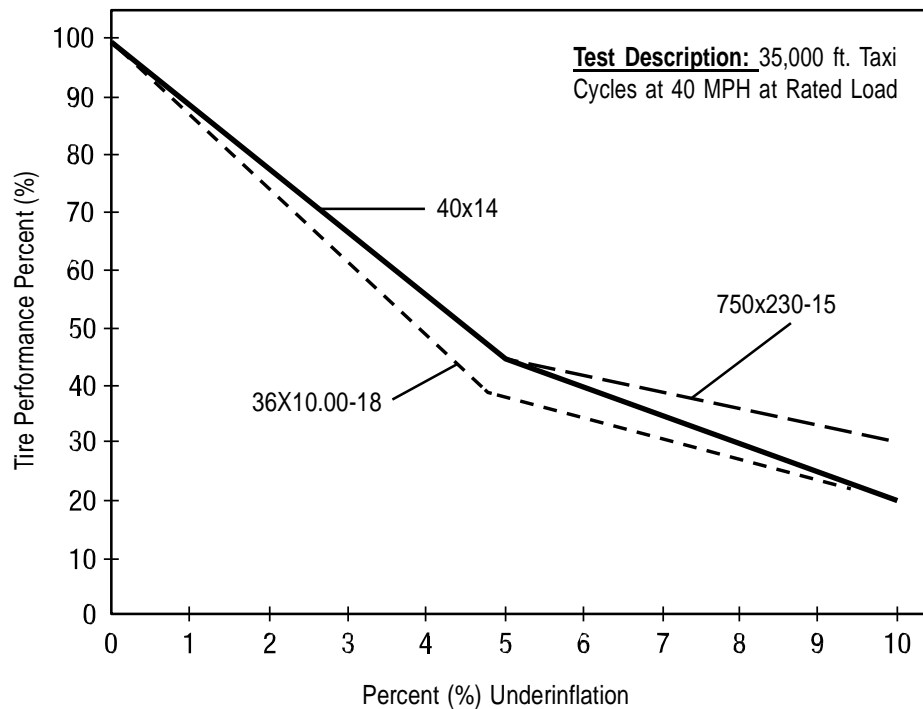

To demonstrate how rapid carcass fatigue can occur due to underinflation, the chart above shows the average of three different tire sizes run at the following conditions:

1. One tire of each size was run on successive taxi cycles consisting of 35,000 ft. each at 40 mph. This was repeated until tire failure occurred. Since this tire was properly inflated, the test result was recorded as 100% durability performance.
2. A second tire of each group was run to the same test, but was 5% underinflated.
3. A third tire of each group was also run to the same test, but at 10% underinflation.

Obviously, one would expect the tire durability to decrease with underinflation. What's impressive, however, is the magnitude of reduction.

To further study the effect of underinflation on tire failure, additional tests were run on the dynamometer. Several tires, at various degrees of underinflation, were run to failure. Some tires were run to take-off cycles and others to 10,000 ft. taxi cycles. As would be expected, the cycles to failure decrease as the percent of underinflation increases.

Effects of Operating Conditions

Cycles to Failure Versus Underinflation

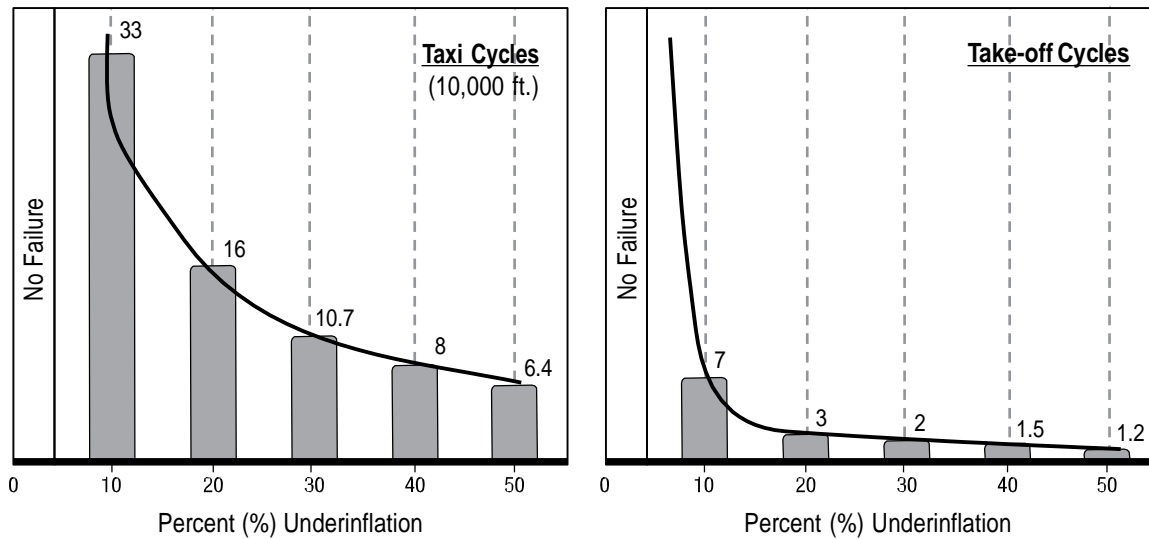

A couple of interesting findings in this study were that all the taxi cycle failures were blowouts in the lower sidewall, while the take-off cycle failures were thrown treads. From the shape of the curves we see that takeoff cycles were more sensitive to underinflation than were taxi cycles.

Cycles to Failure Versus Overload

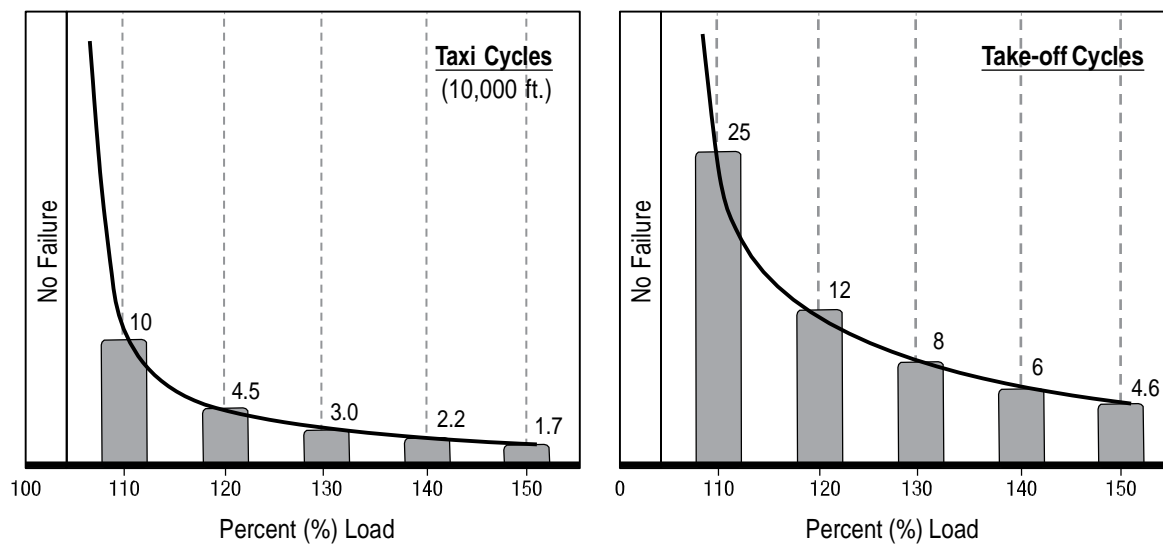

To determine if overloading has the same detrimental affect on tire life as underinflation, the same tests were run on several tires with increasing overloads. As expected, the more a tire is overloaded the quicker it fails.

A couple of interesting findings in this study were that all the taxi cycle failures were still lower sidewall blowouts, and only thrown treads occurred during the take-off cycles. This test shows that taxi cycles are, more sensitive to tire overloading.

Effects of Operating Conditions

Tensile, compression, and shear forces in aircraft tires are extremely high. When the tires are not properly maintained, these forces go even higher until the compound and/or fabric start rapid deterioration. When this happens the following problems can occur:

Shoulder Separation

Shoulder separation is most likely to occur between outer plies where the shear forces are highest.

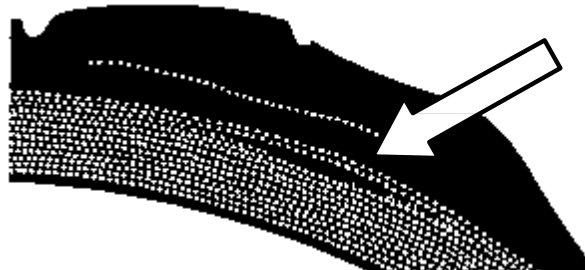

Lower Sidewall Compression Break

This is the start of the type of failure caused by underinflation or overloading. The photo shows carcass cords above the bead area that are starting to fail due to flex fatigue.

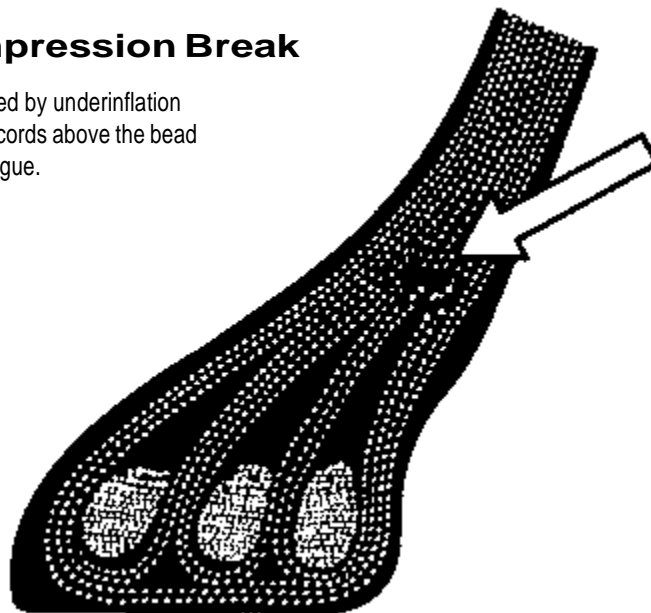

These photos show how underinflation or overloading can cause lower sidewall compression flex breaks.

Effects of Operating Conditions



Sidewall Crack

The first signs of compression flex break in the lower sidewall can appear on the outside sidewall or the inside liner. This photo shows a crack developing in lower sidewall.
Action: Remove from service if fabric is visible.

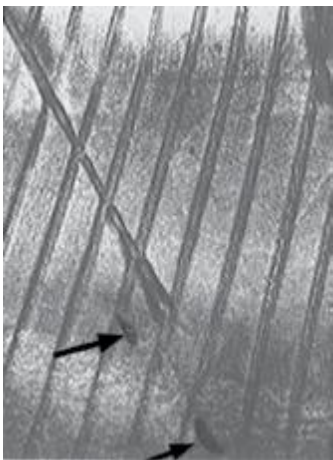

Liner Crack

The first signs of a compression flex break can also appear on the inside liner. This condition will also be apparent by tire pressure loss. This pressure loss then magnifies the problem, resulting in sidewall rupture.
Action: Remove from service.



Massive Separation

During the creation of a sidewall or liner crack, the carcass plies on the inside become severely deteriorated, along with massive separations. This results in possible sidewall rupture.
Action: Remove from service.

These three photographs show the stages of progression. Never mistake these conditions for simply a sidewall or liner crack, as a sidewall rupture is imminent.

Effects of Operating Conditions

Tire Inflation

Heavy loads and high speeds are here to stay. In fact, these demands will probably increase in the future. If they do, centrifugal force, heat generation, tensile, compression and shear forces will also increase.

This section has shown that aircraft tires will function properly only when they have the correct inflation pressure. It has also shown that there is a relatively small amount of tolerance in the amount of deflection in which the tire can operate effectively.

Many times we think we can look at the tire deflection and determine if it is under-inflated, as one might do with passenger car tires. Except in rare circumstances, this cannot be done. This judgment is even more difficult with the aircraft sitting unloaded and low fuel, a condition typical when tire pressures are taken.

QUESTION: Can you tell which tire in this nose gear is underinflated?



ANSWER: No. You cannot tell by looking. The “mate” tire will share the load and the two tires will look equal. Therefore, you should always use a calibrated inflation gauge to check tire pressure.

On a four-wheel or six-wheel gear, visual inspection of a low pressure tire is even less helpful, as there are more tires picking up the load from the underinflated tire.

IMPORTANT - INFLATION PRACTICES

(See Section 4, Proper Inflation Procedures)

1. CHECK DAILY WHEN TIRES ARE COOL
2. INFLATE TO WORST CONDITIONS
3. USE DRY NITROGEN GAS (SAFELY)
4. INCREASE PRESSURE 4% FOR TIRES UNDER LOAD
5. ALLOW 12-HOUR STRETCH AFTER MOUNTING
6. NEVER REDUCE THE PRESSURE OF A HOT TIRE
7. REMEMBER – 1% PRESSURE CHANGE FOR 5°F (3° C)
8. EQUAL PRESSURE FOR DUALS
9. CALIBRATE INFLATION GAUGE REGULARLY

NOTE: Following the suggested maintenance procedures and operating techniques in this manual can greatly extend tire life.

9. Additional Resources

FAA AC 20-97B

This document is a source of information for the installation, inflation, maintenance and removal of aircraft tires.

Limited Warranty for New Goodyear Aviation Tires, Tubes and Retreads

WHAT IS COVERED BY THIS WARRANTY?

This Limited Warranty applies to any new Goodyear aircraft tire or inner-tube furnished or sold by Goodyear and bearing Goodyear's name, or any aircraft tire retreaded by Goodyear, in each case bearing a complete serial number (collectively, "Tires").

WHAT IS NOT COVERED BY THIS WARRANTY?

This Limited Warranty does not cover any condition present as a result of a Tire having been exposed or subjected to:

- (i) alteration, modification, maintenance, repair, installation, handling, transportation, storage, operation or use after delivery that, in Goodyear's judgment, is improper or otherwise not in compliance with the aircraft manufacturer's or Goodyear's published Care & Maintenance Manual instructions; or
- (ii) accident, contamination, foreign object damage, abuse, neglect or negligence occurring after delivery; or
- (iii) damage caused by any aircraft part not supplied by Goodyear,

and Goodyear assumes no responsibility for such condition.

TIRE REPAIRS AND REPLACEMENTS FOR COVERED TIRES

If a Tire with a covered warranty condition becomes unserviceable, Goodyear will, at its option, (a) provide a credit or other allowance deemed suitable by Goodyear or (b) replace such Tire with a comparable Tire at a reduced cost. Such credit or allowance, or the cost of the replacement tire, will be determined on a prorated basis by the Tire's percentage of remaining groove depth (or, in the case of inner-tubes, time in service) and Goodyear's most recent "AP-3" price list, less any applicable discounts. A "comparable" Tire may be the same line of tire or another line. Whether a Tire has a covered warranty condition will be determined by Goodyear after Goodyear's inspection of the returned product.

DISCLAIMER

THIS LIMITED WARRANTY IS EXCLUSIVE AND IN LIEU OF ALL OTHER WARRANTIES OF GOODYEAR WITH RESPECT TO GOODYEAR AVIATION TIRES, TUBES AND RETREADED AVIATION TIRES, WHETHER WRITTEN OR ORAL, EXPRESS, IMPLIED, OR STATUTORY, INCLUDING BUT NOT LIMITED TO ANY IMPLIED WARRANTIES OF MERCHANTABILITY OR FITNESS FOR PARTICULAR PURPOSE, WHICH ARE HEREBY EXPRESSLY DISCLAIMED. IN NO EVENT SHALL GOODYEAR BE LIABLE UNDER THIS WARRANTY FOR INCIDENTAL OR CONSEQUENTIAL DAMAGES. GOODYEAR'S LIABILITY SHALL NOT EXCEED THE NET PURCHASE PRICE OF THE TIRE, AFTER ALL DISCOUNTS. NO EXTENSION OF THIS WARRANTY SHALL BE BINDING UPON GOODYEAR UNLESS SET FORTH IN WRITING AND SIGNED BY A GOODYEAR AUTHORIZED REPRESENTATIVE.

To the extent any Tire condition is covered by any other warranty, such as a warranty from a third party repairer, Goodyear will have no responsibility for that condition.

HOW DO YOU SUBMIT A WARRANTY CLAIM?

To submit a claim under this Limited Warranty, the Tire must be returned to the point of purchase, freight prepaid, by the owner or end-user for inspection and submission of any required claim forms.

Notes

Notes

Notes



www.goodyearaviation.com

Aviation Tires

The Goodyear Tire & Rubber Company

200 Innovation Way

Akron, Ohio 44316-0001, U.S.A.

PH: 330-796-2121

Fax: 330-796-6535